

No part of this handbook may be reproduced,
transcribed, translated into any language or transmitted
in any form whatsoever without the prior written
consent of Codan Pty Ltd.

© Copyright 1997 Codan Pty Ltd.

Codan part number 15-04076 Issue 1, 1997



Contents

1 About this manual

2 Installation

Type of station	2-2
Mounting the transceiver	2-5
Mounting the control head and loudspeaker	2-8
Power supply.....	2-11
Grounding	2-12
Ancillary equipment	2-13

3 Channel and scan table setup

Channel creation and editing	3-2
Channel creation in Free-Tune Receiver mode	3-17
Channel deletion.....	3-21
Scan table creation.....	3-22
Scan table deletion	3-27
Telephone directory creation	3-29

4 Using Setup mode procedures

Using Setup mode	4-2
List of Setup mode procedures.....	4-3
Advanced users.....	4-7

5 Setup procedures—part 1

ALE alphanumeric address setup	5-2
ALE option reset.....	5-4

ALE option settings 5-6
ALE sounding interval 5-13
Beep loudness 5-15
Call preamble length..... 5-17
Call privacy on/off 5-19
Clock calibration..... 5-21
Clock setting 5-23
Clone a transceiver 5-28

6 Setup procedures—part 2

Display brightness..... 6-2
Display contrast 6-4
Display diagnostics on/off 6-6
Display frequency 6-8
Emergency selcall receive setup 6-11
Emergency selcall transmit setup 6-15
Free-Tune Receiver mode availability on/off 6-19
GPS display on/off 6-21
GPS timeout on/off 6-23

7 Setup procedures—part 3

Page call canned message setup 7-2
Password entry to enable transceiver options 7-5
Power up message on/off..... 7-10
Power up mute setting 7-13
Power up address display on/off 7-16
PTT release beep on/off..... 7-18
PTT transmit cutout 7-20
Recall channels by frequency on/off 7-22
RF gain on/off..... 7-24
RS-232 connected equipment 7-26
RS-232 connection baud rate..... 7-29

8 Setup procedures—part 4

Scan table automatic scanning start.....	8-2
Scan table editing on/off	8-4
Selcall address setup	8-6
Selcall address size compatibility	8-13
Selcall lockout on/off	8-16
Selcall mute availability on/off.....	8-18
Status call availability on/off	8-20
Telcall availability on/off	8-22
Tone call setup.....	8-24
99-beacon call response on/off	8-27

9 Link Setup mode

Link Setup mode enter/exit	9-2
Antenna band or channel control	9-5
PIN setup.....	9-8
Setup mode availability on/off.....	9-11
Transceiver reset to factory settings.....	9-13

10 Display messages

11 Appendix

Connectors.....	11-2
Connecting ancillary equipment.....	11-8
Using the optional RS-232/I ² C Interface	11-10
Specifications.....	11-14
Accessories	11-15

Index

Figures

Figure 2.1	A typical fixed base station.....	2-2
Figure 2.2	A typical mobile station.....	2-3
Figure 2.3	Rear view of control head without cover	2-8
Figure 4.1	The Setup mode tree.....	4-9
Figure 9.1	Moving the link for Link Setup mode	9-2

1 About this manual

This manual describes how you set up your Codan HF SSB transceiver.

This issue of the manual incorporates operating information for software versions from:

- transceiver (main) 4.00
- head (control) panel 4.00.

You should refer to this manual when you want to:

- set up the transceiver for the first time
- change how the transceiver operates
- use options or ancillary equipment with the transceiver.

The manual contains 11 chapters.

Chapter 1 explains how to use the manual.

Chapter 2 explains how to install your transceiver and connect the components that make up your station.

Chapter 3 explains how to set up channels, scan tables and the telephone directory.

Chapter 4 explains how to use Setup mode. You should read this before following any Setup mode procedure described in Chapters 5–8.

Chapters 5–8 contain the Setup mode procedures that have been separated into four parts for ease of reference.

Chapter 9 contains Link Setup mode procedures.

Chapter 10 lists all information and error messages output to the transceiver display.

Chapter 11 covers technical information such as the connector pin arrangements, ancillary equipment settings, transceiver specifications, options and accessories.

We recommend that only Codan approved service agents perform maintenance on the transceiver.

Standards and icons

In this manual, Arial typeface is used for text shown on the transceiver display. For example:

If no response was displayed, send the call again.

Arial typeface in bold is used for the names of buttons, knobs and connectors. For example:

Press the **On/Off** button.

This icon...

Means...



the end of a subject.



a warning.

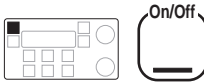

the transceiver button or knob that you need to operate (the **On/Off** button in this example). The solid area in the picture of the control head on the left shows you where to find the button or knob.



the microphone button that you need to operate (the **Call** button in this example). The solid area in the picture of the microphone on the left shows you where to find the button.

Glossary

This term...	Means...
μV	Microvolt.
BER	Bit Error Rate.
A	Ampere.
AC	Alternating Current.
ALE	Automatic Link Establishment.
AM	Amplitude Modulation.
Baud	Binary transfer rate.
Call memory	a list containing details of the last ten calls you have received.
CICS	Computer Interface Command Set.
D	Depth.
dB	Decibel.
DC	Direct Current.
EPROM EEPROM BBPROM SEEPROM	types of Programmable Read-Only Memory.
GPS	Global Positioning System.
H	Height.
HF	High Frequency.
kg	Kilogram.
kHz	Kilohertz.
L/S	Loudspeaker.
LCD	Liquid Crystal Display.
LSB	Lower Sideband.
LU	Lower/Upper sideband selectable.

This term...	Means...
MHz	Megahertz.
mm	Millimetre.
PA	Power Amplifier.
PCB	Printed Circuit Board.
PIN	Personal Identification Number.
PSTN	Public Switched Telephone Network.
PTT button	Press-To-Talk button.
RAM	Random Access Memory.
RDD	Radphone Direct Dial.
Receive-only channel	a channel that allows you to receive calls but not send calls.
Revertive signal	an acknowledgment signal automatically transmitted from a station receiving a call.
RF	Radio Frequency.
RFDS	Royal Flying Doctor Service.
Rx	Receive.
Scan table	a list of channels used when scanning for incoming calls.
Selcall	the simplest type of selective call.
Selective call	a call to a specific station using the station's address. Selective calls include beacon calls, selcalls, group calls, telcalls, GPS calls, page calls, ALE calls and status calls.
SSB	Single Sideband transmission format.
SWR	Standing Wave Ratio.

This term...	Means...
Transceiver ID	a factory set 16-character alphanumeric code that uniquely identifies your transceiver.
Transmit channel	a channel that allows you to receive and send calls.
Two-frequency simplex	a channel that has different transmit and receive frequencies but does not allow simultaneous transmit and receive.
Tx	Transmit.
TXE	Transmit Enabled—allows you to set up new transmit frequencies.
USB	Upper Sideband.
V	Volt.
W	Width.

Other documents

For information on how you use the transceiver to send and receive calls, refer to the *HF SSB transceiver user guide* (Codan part number 15-04073).

For information on the features fitted to your transceiver, refer to the front of your *HF SSB transceiver user guide* for the list of factory fitted transceiver options.

For information on ALE calling, refer to the *9300 ALE controller user guide* (Codan part number 15-04046).

For information on Telstra radiophone services within Australia, refer to the *Radphone Direct Dial User Guide* and *Radphone User Guide* produced by Telstra.



2 Installation

This chapter describes how to install your transceiver and connect the components that make up your station.

It covers:

- type of station (2-2)
- mounting the transceiver (2-5)
- mounting the control head and loudspeaker (2-8)
- power supply (2-11)
- grounding (2-12)
- ancillary equipment (2-13).

On receiving your transceiver, check the contents against the packing list. Make sure that nothing is missing before starting installation.

The procedures for installing your transceiver are not comprehensive. They are to be used as a guide only. We recommend that installation be carried out by qualified and experienced personnel.

Type of station

There are two versions of the transceiver. The front control version has the controls on the front panel of the transceiver. The extended control version has the controls on a separate control head.

There are two types of station:

- fixed base station
- mobile station.

Fixed base station

A fixed base station typically consists of an AC power supply connected directly to the mains. DC output from the power supply is connected to the transceiver, which in turn is connected to an antenna.

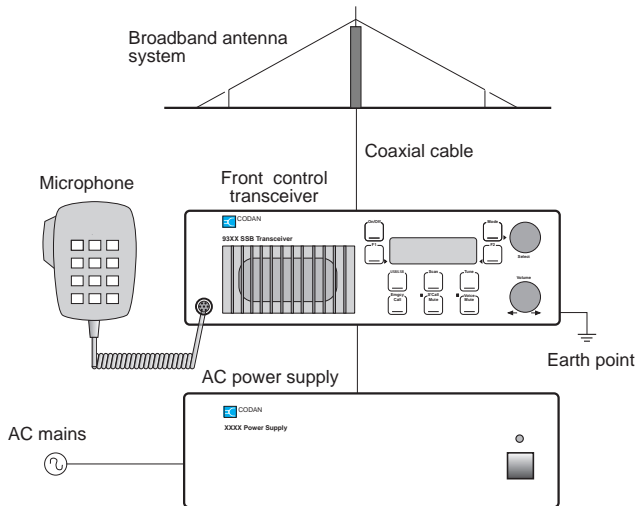

Figure 2.1 A typical fixed base station

Mobile station

A mobile station typically consists of a 12V DC power supply (battery) connected to the transceiver. A coaxial cable connects the antenna to the transceiver. Automatic tuning antennas are also connected to the transceiver by a control cable.

The control head and microphone should be mounted in such a way as to be easily accessible to the operator.

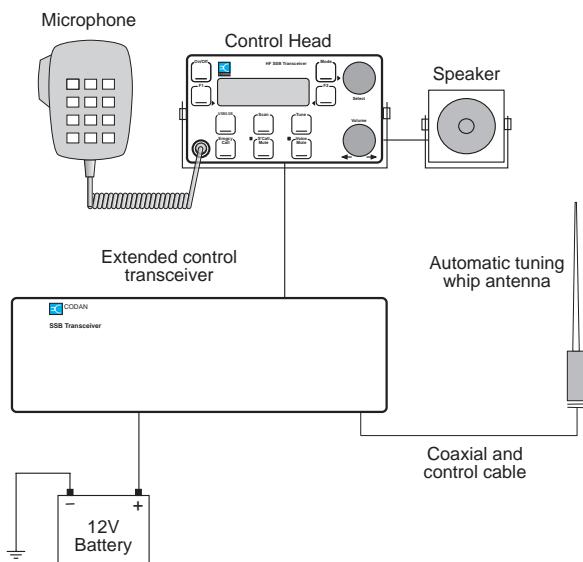

Figure 2.2 A typical mobile station

Where cables must pass through bulkheads with sharp edges, the insulation of the cables should be protected by grommets. Holes in the bulkhead need only be large enough to allow the end of the cable with the smaller connector to pass through (for example, the control cable between the control head and the transceiver).



If the power and control cables are long and follow a common path, keep the cables separated by a minimum of 200mm. The cables can be closer together for short distances, for example, to pass through the same hole in the bulkhead.

Failure to observe this warning will cause distortion of the transmitted audio signals.



Mounting the transceiver



The transceiver must be mounted in a position that:

- *allows easy access to the controls*
- *allows a free flow of air through the rear cooling fins*
- *is not exposed to direct sunlight*
- *will not cause injury to occupants in the event of a motor vehicle accident.*

There are two types of mounting cradles that can be used when installing your transceiver:

- code 117 mounting cradle—front entry
- code 118 mounting cradle—top/bottom entry.

Both types of cradle (supplied with six metres of DC power cable) can be used to mount the transceiver. You must determine the mounting position to best suit your needs.

Code 117 mounting cradle—front entry

This cradle is suitable for locations where there is enough space available to slide the transceiver in and out.

To mount the cradle:

1. Secure the mounting cradle in position with the rotating cam catches to the front. Ensure there is sufficient space at the rear of the cradle to clear the transceiver heat sink and connectors.

2. Align both cam catch slots with the T-section slides.

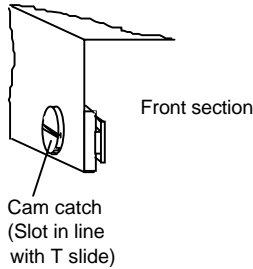

3. Insert the transceiver side rails into the T-section slides and push the transceiver fully into the cradle.
4. Apply gentle pressure to the front of the transceiver and lock it into the cradle by using a flat blade screwdriver to turn the cam catches one quarter of a turn in either direction.

Code 118 mounting cradle—top/bottom entry

To mount the cradle:

1. Secure the mounting cradle into position with its spring clips nearest the front. Ensure there is sufficient space at the rear of the cradle to take the transceiver heat sink and connectors.
2. Remove the front and rear fixing screws of the transceiver side rails (the centre screw to be left untouched).

Note that adaptor plates have to be fitted to the transceiver side rails to secure the transceiver to the cradle.

3. Secure the adaptor plates flush to the transceiver side rails with the new screws provided, and fit one 'O' ring over each projecting stud. The projecting studs on the adaptor plates fit into the slides in the cradle.

4. Insert the transceiver adaptor plates into the cradle slides and push fully into the cradle.
5. Secure the transceiver into the cradle with the spring clips.



Mounting the control head and loudspeaker



*Make sure that the transceiver is disconnected from the DC power source before connecting the control head to the **Remote Control** connector on the transceiver.*

Select a suitable location to mount the control head and loudspeaker. Avoid places exposed to direct sunlight such as the car dashboard close to the windscreen.

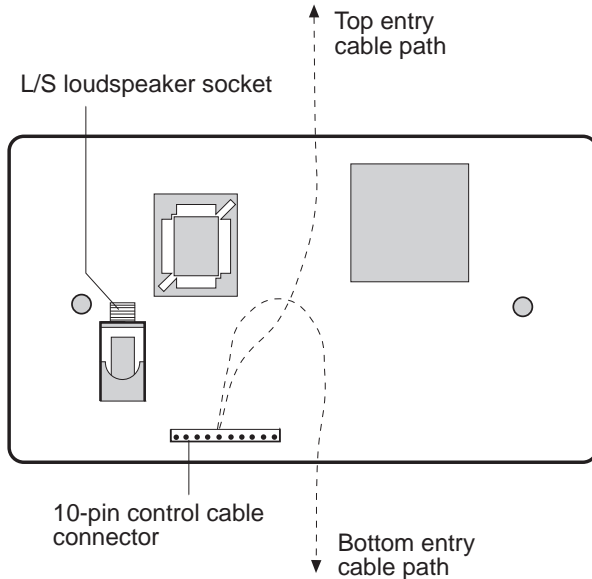

Figure 2.3 Rear view of control head without cover

To connect the control cable and loudspeaker cable to the control head:

1. Remove the two screws on the rear of the control head and remove the cover. Figure 2.3 shows the rear of the control head with the cover removed.
2. Feed the loudspeaker cable through the foam grommet near the control head end of the control cable.
3. Fit the cable clamp to the control cable and attach the cable clamp to the inside of the rear cover of the control head (as shown in the diagram on the inside of the rear cover).
4. Plug the control cable into the 10-pin connector (the cable only fits one way).
5. Plug the loudspeaker cable into the **L/S** loudspeaker socket.
6. Place the foam grommet into the slot on the rear cover.
7. To make sure that the cover will not pinch the cable, position the cable between the shaded areas in Figure 2.3.
8. Replace the rear cover of the control head and its two screws carefully. Note that the rear cover of the control head can be rotated to give you either top or bottom entry of the cables.

The loudspeaker and the control head have similar mounting brackets. The procedure for installing them is the same.

To install the brackets:

1. Remove the two cradle screws and washers securing the mounting cradle to the equipment.
2. Secure the mounting cradle into position. Ensure that there is sufficient space at the rear for the cables.
3. Secure the equipment to the mounting cradle with the two screws and washers.

4. Plug in the control cable at the **Remote Control** connector on the transceiver. Ensure that it is securely fastened.

The control cable is six metres long. Do not cut the control or loudspeaker cable. If either cable is too long, gather the excess neatly and secure it out of the way.

When connecting the microphone, gently rotate the plug in the microphone socket until the pins locate. Push the plug home and fasten the locking ring until finger-tight. Do not over tighten.



Power supply

Ensure that the power supply to operate your transceiver is 12V DC.

Power can be provided by either a 12V battery (for mobile stations) or a suitable power supply connected directly to the mains (for fixed base stations).

All installations should be checked by a qualified technician before power is applied to the transceiver.

The heavy duty six metre length of power cable, which is supplied with the vehicle mounting cradle for mobile stations, minimises the voltage drop between the battery and transceiver during transmission. Do not use a thinner cable than this.

Protect all cables from sharp edges and mechanical abrasions.

We recommend that a suitable cartridge fuse (32 Amp—accessory code 711) is fitted in the active wire, close to the battery. This will protect the power cable from risk of fire should damaged insulation touch the vehicle chassis. Do not use normal glass in-line automotive fuses. The transceiver is fitted with adequate internal protection.

Connect the power cable between the transceiver and the battery or the AC power supply.



In extended control installations where the power and control cables are long and follow a common path, keep the cables separated by a minimum of 200mm. The cables can be closer together for short distances, for example, to pass through the same hole in the bulkhead.

Failure to observe this warning will cause distortion of the transmitted audio signals.



Grounding

A good ground (RF earth) is essential for efficient transceiver operation. A chassis ground is provided on the rear panel of the transceiver.

Use a copper braid of at least 12mm width to ground the transceiver.

The control head may also require earthing to prevent RF interference corrupting its data and audio circuits. To do this, check that the mounting bracket is earthed by ensuring that the screws holding the mounting bracket are not insulated. It may be necessary to remove paint from around the mounting screws to ensure a good contact.



Ancillary equipment

There is a range of ancillary equipment you can connect to the transceiver. For details, see *Chapter 11, Connecting ancillary equipment*.

Antennas and antenna tuners

Correct installation of the antenna and antenna tuner is important for good transceiver operation.

To obtain optimal performance and good radiation efficiency from your transceiver, consider the following for the antenna and antenna tuner:

- physical location
- distance from the transceiver
- grounding.

Follow the installation instructions provided with each antenna and antenna tuner to achieve the best possible performance.



3 Channel and scan table setup

This chapter covers:

- Channel creation and editing (3-2)
- Channel creation in Free-Tune Receiver mode (3-17)
- Channel deletion (3-21)
- Scan table creation (3-22)
- Scan table deletion (3-27)
- Telephone directory creation (3-29).

Channel creation and editing

These procedures are used to:

- create receive-only channels by copying and editing existing channels
- edit unprotected channels
- create transmit channels (if option TXE is fitted to your transceiver).

When you send a call, the channel frequency and sideband have to be the same for both stations. The channel number is unimportant.

You cannot change the transmit frequencies used by your transceiver unless your transceiver is fitted with option TXE. If you edit a transmit channel and change its frequency, it automatically becomes a receive-only channel.

You can change channel comments to describe how each channel is used.

If you regularly use certain channels, grouping them together may be helpful. You do this by copying channels to new channel numbers. For example, you could create a group of 10 channels with channel numbers 201 to 210.

Unless your transceiver has option TXE, the changes you can make to a channel depends on whether the channel is:

- protected or unprotected
- a transmit or receive-only channel.

You can change any unprotected channel setting. The only protected channel setting you can change is the channel comment. If you want to change the settings of a protected channel, make an unprotected copy of the channel and edit this copy.

Transmit channel settings consist of:

- channel frequency
- sideband (upper/lower/selectable)
- tone call group (1–4 or none)
- selcall group (1–5 or none)
- channel protection (on/off)
- channel comment (description of channel).

Receive-only channel settings consist of:

- channel frequency
- sideband (upper/ lower/selectable)
- channel protection (on/off)
- channel comment (description of channel).

The number of channels available in the transceiver depends on how much of the transceiver's memory is used to hold channel comments. 400 channels are available if only a few channel comments are used. 200 channels may be available if all channels have channel comments.







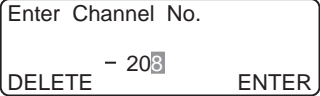

Creating or editing a channel





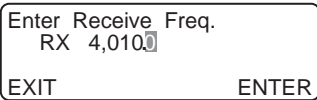

This procedure is used to create and edit channels. It does not allow you to create transmit channels with new transmit frequencies. Option TXE is required for this.

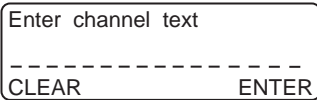
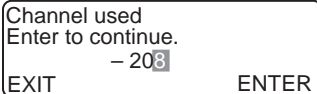

If you have option TXE fitted to your transceiver, follow the procedure in *Creating a transmit channel* on page 3-11.

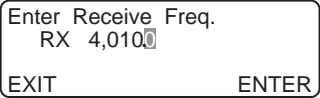
To create or edit a channel:

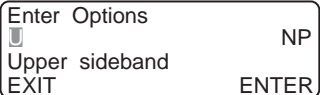

Action	Notes
<p>1. In Channel mode, select the channel frequency that you want to copy or edit.</p>	<p>If you want to create a receive-only channel, you can select any channel.</p>
<p>2. Press twice</p> 	<p>Example of the display:</p> 
<p>3. Do you want to create a channel with a new channel number?</p> <p>Yes ➤ Step 4.</p> <p>No ➤ Step 6.</p>	<p>Answer:</p> <ul style="list-style-type: none"> • Yes if you want to create a channel by copying or changing information from this channel • No if you want to edit this channel (that is, save your changes to this channel).

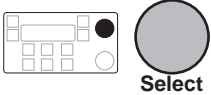

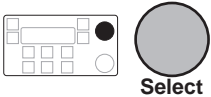
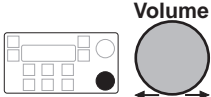
Action	Notes
<p>4. Enter the number of the new channel</p>  	<p>Do not enter the number of a channel that already exists.</p>
<p>5. Press</p>   <p>Continue ➤ Step 9.</p>	<p>Example of the display:</p>  <p>If you entered the number of a channel that already exists, the transceiver beeps. Start the procedure again by pressing</p>  <p>PTT</p>
<p>6. (From Step 3.)</p> <p>To edit this channel, press</p>  	<p>If this channel is protected, the display looks like this:</p>  <p>If this channel is unprotected, the display looks like this:</p> 

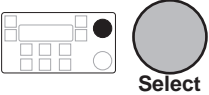
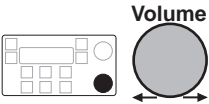
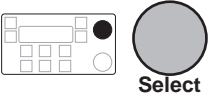
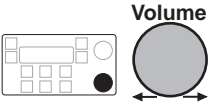
Action	Notes
<p>7. Is this channel protected?</p> <p>Yes ➤ Step 22.</p> <p>No ➤ Step 8.</p>	<p>If this channel is protected, you can only change its channel comment.</p>
<p>8. Press</p>  	<p>Example of the display:</p> 
<p>9. Are you changing the receive frequency or is this a receive-only channel?</p> <p>Yes ➤ Step 10.</p> <p>No ➤ Step 13.</p>	<p>Answer yes if either or both of these questions are true.</p>
<p>10. To change the frequency, enter the new value</p>   <p>numeral button</p>	<p>Enter the kHz frequency to two decimal places. For example, to enter 2040kHz, enter 204000.</p> <p>Entering a frequency automatically makes this a receive-only channel.</p>
<p>11. Press</p>  	<p>Example of the display:</p> 

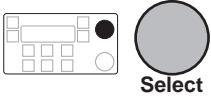
Action	Notes
<p>12. To change the sideband setting, rotate</p>  <p>Continue ➤ Step 19.</p>	<p>Select:</p> <ul style="list-style-type: none"> • U for upper sideband • L for lower sideband • LU for either sideband to be selectable.
<p>13. (From Step 9.)</p> <p>Press</p> 	<p>The display shows the channel options:</p> <div style="border: 1px solid black; padding: 5px; width: fit-content;"> <pre> Enter Options U T1 S1 NP Upper sideband EXIT ENTER </pre> </div> <p>If you finish changing channel options at any time in steps 13–20, you can go to step 21.</p>
<p>14. To change the sideband setting, rotate</p> 	<p>Select:</p> <ul style="list-style-type: none"> • U for upper sideband • L for lower sideband • LU for either sideband to be selectable.
<p>15. To move to the tone call group setting, rotate</p> 	<p>Example of the display:</p> <div style="border: 1px solid black; padding: 5px; width: fit-content;"> <pre> Enter Options U T1 S1 NP Hi: 1320 Lo: 880 EXIT ENTER </pre> </div>

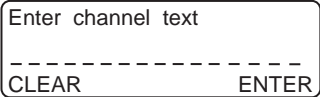
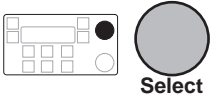
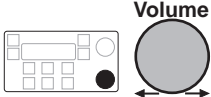
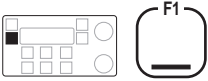
Action	Notes
<p>16. To change the tone call group setting, rotate</p> 	<p>Select:</p> <ul style="list-style-type: none"> • T1 to T4 to use this channel for tone calls • T- to disallow tone calls on this channel.
<p>17. To move to the selcall group setting, rotate</p> 	<p>Example of the display:</p> <pre> Enter Options U T1 S1 NP Self Id: ----- Codan EXIT ENTER </pre>
<p>18. To change the selcall group setting, rotate</p> 	<p>Select:</p> <ul style="list-style-type: none"> • S1 to S5 to use this channel for selcalls • S- to disallow selcalls on this channel.
<p>19. To move to the channel protection setting, rotate</p> 	<p>Example of the display:</p> <pre> Enter Options U T1 S1 NP Not protected EXIT ENTER </pre> <p>or</p> <pre> Enter Options U T1 S1 NP Not protected EXIT ENTER </pre>





Action	Notes
<p>20. To change the channel protection setting, rotate</p> 	<p>Select:</p> <ul style="list-style-type: none"> • NP to leave this channel unprotected. • P to protect this channel from all changes <p>Caution! Once you protect a channel, only a Codan agent can change or delete this channel without deleting all channels from the transceiver unless option TXE has been enabled.</p>
<p>21. Press</p> 	<p>Example of the display:</p> 
<p>22. To enter a comment to describe this channel, select each character using</p>  <p>and move between characters using</p> 	<p>Enter up to 20 characters (for example, Local Network).</p> <p>To clear any existing text, press</p> 







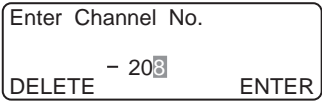



Action	Notes
<p data-bbox="182 215 566 308">23. To save all changes for the edited or copied channel, press</p>  	<p data-bbox="631 215 976 276">There is a pause before the display looks like this example:</p> 





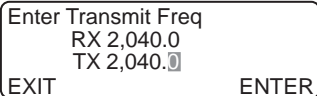

Creating a transmit channel

This procedure is used to create transmit channels with new transmit frequencies when your transceiver has option TXE (Transmit Enable). Under special circumstances TXE may be fitted at the time of purchase where local licensing authorities permit.

To create a transmit channel:

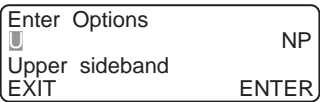



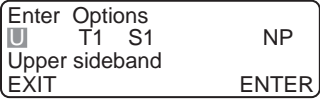

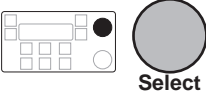
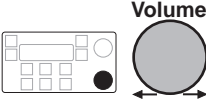
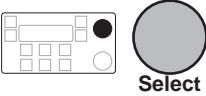
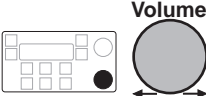
Action	Notes
<p>1. In Channel mode, select any channel.</p>	
<p>2. Press twice</p>  	<p>Example of the display:</p> 
<p>3. Enter the number of the channel</p>  	<p>Leave the number unchanged if you want to edit channel information for this channel number instead of saving changes under a new channel number.</p>

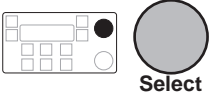
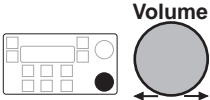
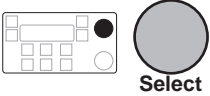
	Action	Notes
4.	Press  	If the channel already exists, the transceiver beeps. To edit this channel, press   Example of the display: 
5.	To change the receive frequency, enter the new value   numeral button	Enter the kHz frequency to two decimal places. For example, to enter 2040kHz, enter 204000.
6.	Press  	Example of the display: 
7.	To change the transmit frequency, enter the new value   numeral button	Enter the kHz frequency to two decimal places. To inhibit transmission on this channel, enter 0.

Action	Notes
<p>8. Is transmission inhibited on this channel?</p> <p>Yes ➤ Step 9. No ➤ Step 11.</p>	
<p>9. Press</p>  	<p>Example of the display:</p> 
<p>10. To change the sideband setting, rotate</p>   <p>Continue ➤ Step 17.</p>	<p>Select:</p> <ul style="list-style-type: none"> • U for upper sideband • L for lower sideband • LU for either sideband to be selectable.
<p>11. (From Step 8.)</p> <p>Press</p>  	<p>The display shows the channel options:</p>  <p>If you finish changing channel options at any time in steps 11–18, you can go to step 19.</p>

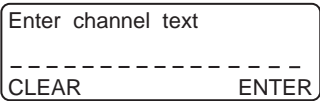
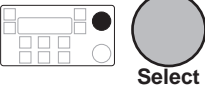
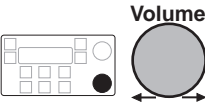
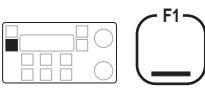
Action	Notes
<p>12. To change the sideband setting, rotate</p> 	<p>Select:</p> <ul style="list-style-type: none"> • U for upper sideband • L for lower sideband • LU for either sideband to be selectable.
<p>13. To move to the tone call group setting, rotate</p> 	<p>Example of the display:</p> <pre> Enter Options U T1 S1 NP Hi: 1320 Lo: 880 EXIT ENTER </pre>
<p>14. To change the tone call group setting, rotate</p> 	<p>Select:</p> <ul style="list-style-type: none"> • T1 to T4 to use this channel for tone calls • T- to disallow tone calls on this channel.
<p>15. To move to the selcall group setting, rotate</p> 	<p>Example of the display:</p> <pre> Enter Options U T1 S1 NP Self Id: ----- Codan EXIT ENTER </pre>

Action	Notes
<p>16. To change the selcall group setting, rotate</p> 	<p>Select:</p> <ul style="list-style-type: none"> • S1 to S5 to use this channel for selcalls • S- to disallow selcalls on this channel.
<p>17. (From Step 10.) To move to the channel protection setting, rotate</p> 	<p>Example of the display:</p> <pre> Enter Options U T1 S1 NP Not protected EXIT ENTER </pre> <p>or</p> <pre> Enter Options U T1 S1 NP Not protected EXIT ENTER </pre>
<p>18. To change the channel protection setting, rotate</p> 	<p>Select:</p> <ul style="list-style-type: none"> • NP to leave this channel unprotected • P to protect this channel from all changes. <p>Protection only applies when TXE is disabled.</p>

	Action	Notes
19.	<p>Press</p>  	<p>Example of the display:</p> 
20.	<p>To enter a comment to describe this channel, select each character using</p>  <p>and move between characters using</p> 	<p>Enter up to 20 characters (for example, Local Network).</p> <p>To clear any existing text, press</p> 
21.	<p>To save all changes for the channel, press</p>  	<p>There is a pause before the display looks like this example:</p> 





Channel creation in Free-Tune Receiver mode





This procedure is used to create receive-only channels in Free-Tune Receiver mode.

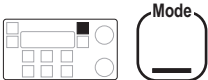
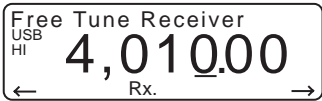

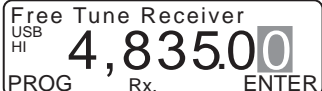

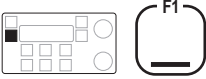
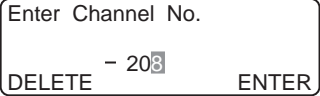
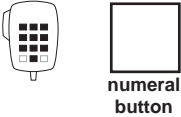
This procedure is similar to *Channel creation and editing* (see page 3-2 for details) except that you cannot create transmit channels.

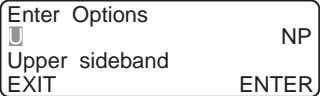

After using Free-Tune Receiver mode to tune the transceiver to a new channel frequency, this procedure is useful for saving the frequency under a new channel number.

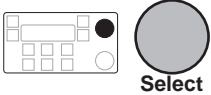
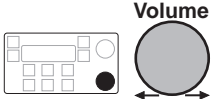
To create a receive-only channel in Free-Tune Receiver mode:

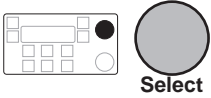
Action	Notes
<p>1. Repeatedly press</p>  <p>until you see the display for Free-Tune Receiver mode.</p>	<p>Example of the display:</p> 
<p>2. Make any changes to the frequency.</p>	<p>Refer to the <i>HF SSB transceiver user guide, Chapter 3, Using Free-Tune Receiver mode.</i></p>
<p>3. Press</p> 	<p>Example of the display:</p> 

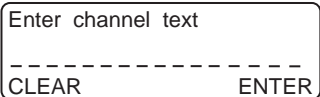
Action	Notes
<p>4. Press</p> 	<p>Example of the display:</p> 
<p>5. Enter the number of the new channel</p> 	<p>Do not enter the number of a channel that already exists.</p>
<p>6. Press</p> 	<p>The display should look like this:</p>  <p>If you entered the number of a channel that already exists, the transceiver beeps. Start the procedure again by pressing</p> 

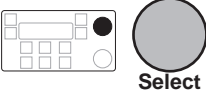
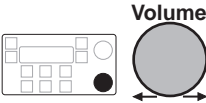
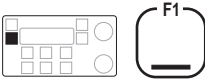
Action	Notes
<p>7. To change the sideband setting, rotate</p> 	<p>Select:</p> <ul style="list-style-type: none"> • U for upper sideband • L for lower sideband • LU for either sideband to be selectable.
<p>8. To move to the channel protection setting, rotate</p> 	<p>Example of the display:</p> 
<p>9. To change the channel protection setting, rotate</p> 	<p>Select:</p> <ul style="list-style-type: none"> • NP to leave this channel unprotected • P to protect this channel from all changes. <p>Caution! Once you protect a channel, only a Codan agent can change or delete this channel without deleting all channels from the transceiver.</p>
<p>10. Press</p> 	<p>Example of the display:</p> 

Action	Notes
<p data-bbox="183 215 561 338">11. To enter a comment to describe this channel, select each character using</p>  <p data-bbox="314 488 516 547">and move between characters using</p> 	<p data-bbox="631 215 956 276">Enter up to 20 characters (for example, Local Network).</p> <p data-bbox="631 296 916 355">To clear any existing text, press</p> 
<p data-bbox="183 751 545 842">12. To return to Channel mode saving the new channel, press</p> 	<p data-bbox="631 751 975 810">There is a pause before the display looks like this example:</p> 





Channel deletion

This procedure is used to delete unprotected channels.

Only a Codan agent can change or delete a protected channel unless you have option TXE fitted.

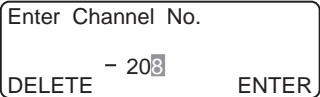
To delete an unprotected channel:

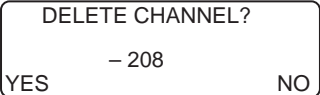
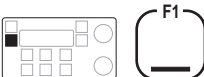
Action	Notes
<p>1. In Channel mode, select the channel that you want to delete.</p>	<p>Unprotected channels show the unprotected marker (small dot) at the bottom left of the display.</p>
<p>2. Press twice</p> 	<p>Example of the display:</p> 
<p>3. Press</p> 	<p>Example of the display:</p> 
<p>4. Press</p> 	<p>The transceiver beeps after the channel has been deleted.</p>



Scan table creation

This procedure is used to set up any of the three scan tables.

You can only make changes to scan tables if scan table editing is switched on (see *Chapter 8, Scan table editing on/off*).

Each scan table can hold up to ten receive frequency channels. You can add a channel to the scan table more than once if you want the channel to be scanned several times in each scan cycle.

You can select one of five scan types as displayed:

- | | |
|----------------|---|
| Selcall | <p>Selcall scanning is the normal setting if you expect to receive selcalls. Mute is on so that no voice transmissions are heard. (Use of selcall mute needs to be on. See <i>Chapter 8, Selcall mute availability on/off</i>.)</p> <p>Each channel is scanned for 0.6 seconds.
Scanning only stops for selcalls.</p> |
| Cont | <p>Use Continuous scanning if you want to listen to voice traffic as the channels are scanned.</p> <p>Each channel is scanned for 0.6 seconds.
Scanning only stops for selcalls. Mute is off.</p> |
| Pause | <p>Use Pause scanning if you expect voice calls and want scanning to pause for five seconds when voice is detected on the channel.</p> <p>Each channel is scanned for one second.
Scanning also stops for selcalls.</p> |

Hold Use Hold scanning if you expect voice calls and want scanning to hold for as long as the voice is detected on the channel.





Each channel is scanned for one second.
Scanning also stops for selcalls.

ALE Use ALE scanning if you are using an ALE controller and expect ALE calls.

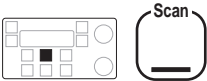
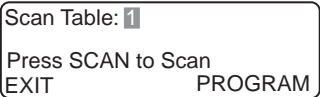
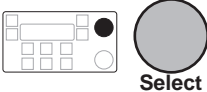
Scanning stops for both selcall and ALE calls.
Mute is on.

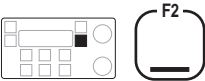
To set up a scan table:

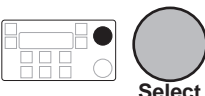
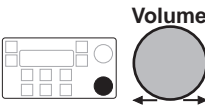
Action	Notes
<p>1. In Channel mode, press</p> 	<p>Example of the display:</p> 
<p>2. To select one of the three scan tables, rotate</p> 	<p>Select scan table 1, 2 or 3.</p>

	Action	Notes
<p>3.</p>	<p>Press</p> 	<p>For example, scan table 2 looks like this:</p> <div style="border: 1px solid black; padding: 5px; width: fit-content;"> <p>Scan Table: 2 F1 to delete table F2 to program table DELETE ENTER</p> </div>
<p>4.</p>	<p>Press</p> 	<p>Example of the display:</p> <div style="border: 1px solid black; padding: 5px; width: fit-content;"> <p>Scan Table: 2 ----- Enter Scan name CLEAR ENTER</p> </div>
<p>5.</p>	<p>To enter a comment to describe this scan table, select each character using</p>  <p>and move between characters using</p> 	<p>Enter up to 20 characters (for example, Local Network).</p> <p>To clear any existing text, press</p> 
<p>6.</p>	<p>Press</p> 	<p>Example of the display:</p> <div style="border: 1px solid black; padding: 5px; width: fit-content;"> <p>Scan Table: 2 Default Scan: Cont Continuous scan EXIT ENTER</p> </div>

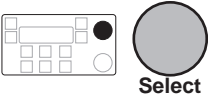
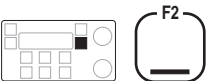
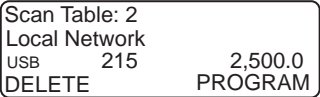
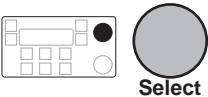
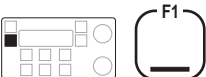
Action	Notes
<p>7. To switch between the types of scanning, rotate</p> 	<p>Select:</p> <ul style="list-style-type: none"> • Selcall—for normal selcall scanning • Cont—for selcall scanning without muting channel traffic • Pause—for voice call scanning to pause five seconds on voice detection • Hold—for voice call scanning to hold on voice detection • ALE—for ALE call scanning.
<p>8. Press</p> 	<p>Example of the display:</p> 
<p>9. To select the channel to add to the scan table, rotate</p> 	<p>You can add up to ten channels to the scan table.</p> <p>To delete a channel already added to the scan table, press</p> 

Action

Notes

10.

To add the displayed channel to the scan table, press

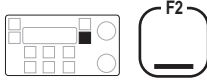

Prog x1 indicates that this channel is now entered once in the scan table:

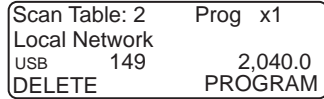

11.

Do you want to add another channel to the scan table?

Yes ➤ **Step 9.**

No ➤ **Step 12.**

12.

To save your changes, press

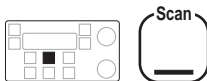

Example of the display:



Return to Step 2 to program another scan table.





Scan table deletion

This procedure is used to delete any of the three scan tables.

You can only delete scan tables if scan table editing is switched on (see *Chapter 8, Scan table editing on/off*).

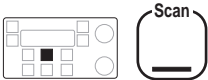
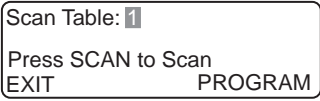
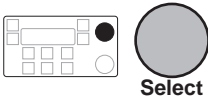
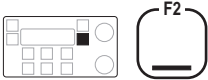
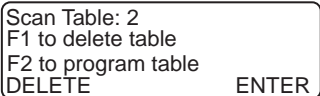
To delete a scan table:

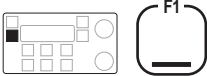
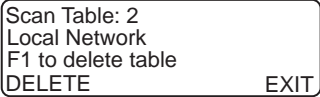
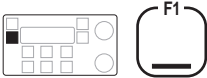
Action	Notes
<p>1. In Channel mode, press</p> 	<p>Example of the display:</p> 
<p>2. To select one of the three scan tables for deletion, rotate</p> 	<p>Select scan table 1, 2 or 3.</p>
<p>3. Press</p> 	<p>For example, scan table 2 looks like this:</p> 

Action	Notes
<p data-bbox="182 217 374 240">4. Press</p> 	<p data-bbox="633 217 891 240">Example of the display:</p> 
<p data-bbox="182 440 512 496">5. To delete the scan table, press</p> 	<p data-bbox="633 440 891 464">Example of the display:</p> 







Telephone directory creation







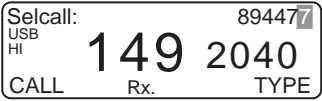

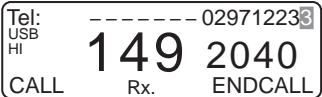

This procedure is used to set up the telephone directory for sending telcalls.

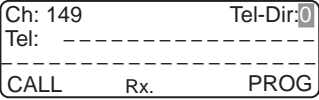
The telephone directory operates like a telephone book. It can hold ten telephone entries (numbered 0–9). Each entry consists of a telephone number and a comment.

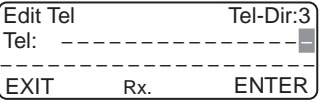

You can only access the telephone directory from channels that allow selcalling (channels attached to a selcall group). To check the selcall group setting for a channel, refer to the *HF SSB transceiver user guide, Chapter 3, Using View Channel Options mode*.

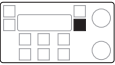
To add or clear entries from the telephone directory:

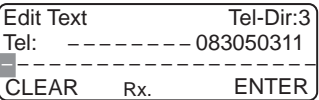
Action	Notes
<p>1. In Channel mode, select a channel that is set up for selcalling.</p>	<p>You can only access the telephone directory from a selcall channel.</p>
<p>2. Press</p> <div style="display: flex; align-items: center; justify-content: center; gap: 20px;">   </div>	<p>Example of the display:</p> 
<p>3. Press</p> <div style="display: flex; align-items: center; justify-content: center; gap: 20px;">   </div>	<p>Example of the display:</p> 

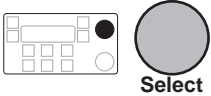
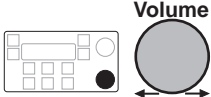
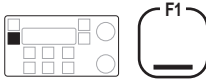
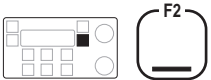
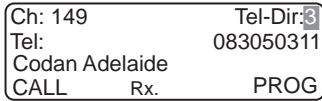
	Action	Notes
4.	Press  	Example of the display: 
5.	To select one of the ten entries, rotate   Select	Select an entry from 0 to 9.
6.	Press  	For example, entry 3 looks like this: 
7.	Enter the telephone number   numeral button	To cancel an existing number and leave this entry unused, enter 0.
8.	Press  	For example, number 083050311 looks like this: 

Action	Notes
<p data-bbox="236 217 594 304">9. To enter a comment, select each character using</p>  <p data-bbox="370 456 572 512">and move between characters using</p> 	<p data-bbox="687 217 997 336">Enter up to 20 characters to describe the number (for example, person's name and location).</p> <p data-bbox="687 360 969 416">To clear any existing text, press</p> 
<p data-bbox="236 719 611 775">10. To save your changes, press</p> 	<p data-bbox="687 719 941 743">Example of the display:</p> 
<p data-bbox="236 967 577 1054">11. Do you want to add another telephone number?</p> <p data-bbox="370 1078 577 1134">Yes ➤ Return to Step 5.</p> <p data-bbox="370 1142 577 1168">No ➤ Step 12.</p>	

Action	Notes
<p data-bbox="183 215 546 276">12. To return to Channel mode, press</p>  PTT	<p data-bbox="632 215 956 244">Example of the display:</p> 



4 Using Setup mode procedures

Setup mode allows you to view and change settings that control transceiver operation.

This chapter:

- explains how to use Setup mode (4-2)
- lists the procedures available in Setup mode (4-3)
- gives some tips on using Setup mode for advanced users (4-7).

You should read this chapter before running any of the Setup mode procedures. Chapters 5–8 cover in detail the Setup mode procedures for the full range of HF SSB series transceivers. Not all of these procedures may be available in your transceiver.

You can only use the Setup mode procedures that:

- are standard for all HF SSB series transceivers (see *List of Setup mode procedures* on page 4-3)
- correspond to transceiver options factory fitted for your version of the transceiver in the HF SSB series range (refer to the front of your *HF SSB transceiver user guide* for the list of factory fitted transceiver options)
- correspond to transceiver options that you have additionally enabled in your transceiver by using passwords (see *Chapter 7, Password entry to enable transceiver options*).

Using Setup mode

You enter Setup mode by pressing the **Mode** button on the control panel four times starting from the Channel mode setting.

Setup mode only displays the names of Setup mode procedures fitted or enabled for your transceiver. The names of unavailable procedures are blanked out.

The easiest way to use Setup mode is to find the procedure you want from the following list and turn to the description of the procedure for further details and step by step guidance. Procedures are listed alphabetically in Chapters 5–8.

You start each transceiver procedure by entering a setup code.

If you make a mistake in setting a value and want to avoid saving your changes, press the **F1** button on the control panel or **PTT** on the microphone to return to an earlier step in the procedure. Repeated pressing of either button progresses you back to Channel mode.

If you do not touch any button or knob for 60 seconds while in Setup mode, the transceiver automatically reverts to Channel mode. If this happens while you are in the middle of a procedure, start the procedure again.

The descriptions for the procedures show examples of channel and frequency numbers. You must enter your own values.



List of Setup mode procedures

Procedures labelled standard are available in all HF SSB series transceivers.

Procedure	Page	Setup code	Description
ALE alphanumeric address	5-2	2434	Sets the alphanumeric address of your transceiver.
ALE option reset	5-4	2432	Resets 9 of the 17 ALE option settings 0–16 to their factory values.
ALE option settings	5-6	2431	Changes how the ALE controller works.
ALE sounding interval	5-13	2433	Changes the ALE sounding time interval.
Beep loudness (standard)	5-15	33	Changes the volume of beeps made by the transceiver.
Call preamble length	5-17	242	Sets the length of the preamble transmitted at the start of a selective call.
Call privacy on/off	5-19	2443	Limits the stations that can receive your transmissions of GPS, page and status call information.
Clock calibration (standard)	5-21	412	Calibrates the transceiver clock against an external standard.
Clock setting (standard)	5-23	411	Sets the time and date of the transceiver clock.

Procedure	Page	Setup code	Description
Clone a transceiver (standard)	5-28		Copies the settings from one transceiver to another by a process called cloning.
Display brightness (standard)	6-2	311	Changes the brightness of the display.
Display contrast (standard)	6-4	312	Changes the contrast of the display.
Display diagnostics on/off (standard)	6-6	314	Switches on or off the display of diagnostic information about your transceiver.
Display frequency (standard)	6-8	313	Sets how the frequency is displayed for each channel.
Emergency selcall receive setup	6-11	24422	Sets up the transceiver for receiving emergency selcalls.
Emergency selcall transmit setup	6-15	24421	Sets up the transceiver for sending emergency selcalls.
Free-Tune Receiver mode availability on/off (standard)	6-19	3442	Switches on or off the availability of Free-Tune Receiver mode.
GPS display on/off	6-21	3421	Switches on or off the display of your transceiver's GPS location.
GPS timeout on/off	6-23	3422	Switches on or off the GPS timeout warning.
Page call canned message setup	7-2	24441	Prepares and stores up to three messages ready for sending in a page call.

Procedure	Page	Setup code	Description
Password entry to enable transceiver options (standard)	7-5	42	Enables transceiver options that are built into the transceiver and deletes forgotten PINs.
Power up message on/off (standard)	7-10	34411	Allows you to set up a message that is displayed for several seconds when the transceiver is first switched on.
Power up mute setting (standard)	7-13	34412	Selects the initial mute setting that is used when the transceiver is first switched on.
Power up address display on/off	7-16	34413	Selects whether or not your address, set up in selcall group 1, is briefly displayed when the transceiver is first switched on.
PTT release beep on/off (standard)	7-18	3432	Switches on or off PTT release beeping.
PTT transmit cut-out (standard)	7-20	3431	Prevents the transceiver from being left on in the transmit state by mistake.
Recall channels by frequency on/off (standard)	7-22	32	Selects whether or not you can recall channels by frequency.
RF gain on/off (standard)	7-24	3443	Switches on or off the RF gain.
RS-232 connected equipment (standard)	7-26	3411	Identifies the equipment connected to either the RS-232 socket or GP connector on the transceiver rear panel.
RS-232 connection baud rate (standard)	7-29	3412	Sets the speed of information transfer for equipment connected to the transceiver rear panel.

Procedure	Page	Setup code	Description
Scan table automatic scanning start (standard)	8-2	11	Sets the time delay between finishing a call and resuming automatic scanning.
Scan table editing on/off (standard)	8-4	12	Switches on or off scan table editing.
Selcall address setup	8-6	211	Sets up your address for any of your transceiver's five selcall groups S1–S5.
Selcall address size compatibility	8-13	213	Selects how you communicate with stations that are incapable of using addresses longer than four digits.
Selcall lockout on/off	8-16	2441	Switches on or off selcall lockout.
Selcall mute availability on/off	8-18	212	Switches on or off the availability of selcall mute on the control panel (the S'Call Mute button).
Status call availability on/off	8-20	24442	Switches on or off the ability to send the three types of status call—remote diagnostics call, remote config call and user status call.
Telcall availability on/off	8-22	22	Switches on or off the ability to send telcalls.
Tone call setup (standard)	8-24	23	Sets up the high and low frequency pairs for any of the four tone call groups T1–T4.
99-beacon call response on/off	8-27	241	Switches on or off the ability to respond to received 99-beacon calls (selcalls ending in 99).



Advanced users

This section explains how Setup mode procedures are arranged in the transceiver. You do not need to understand this to use Setup mode, but some readers may find this knowledge useful.

The Setup mode tree in Figure 4.1 shows how Setup mode procedures are accessed. Each menu of options displayed by the transceiver is represented by a branch in this tree.

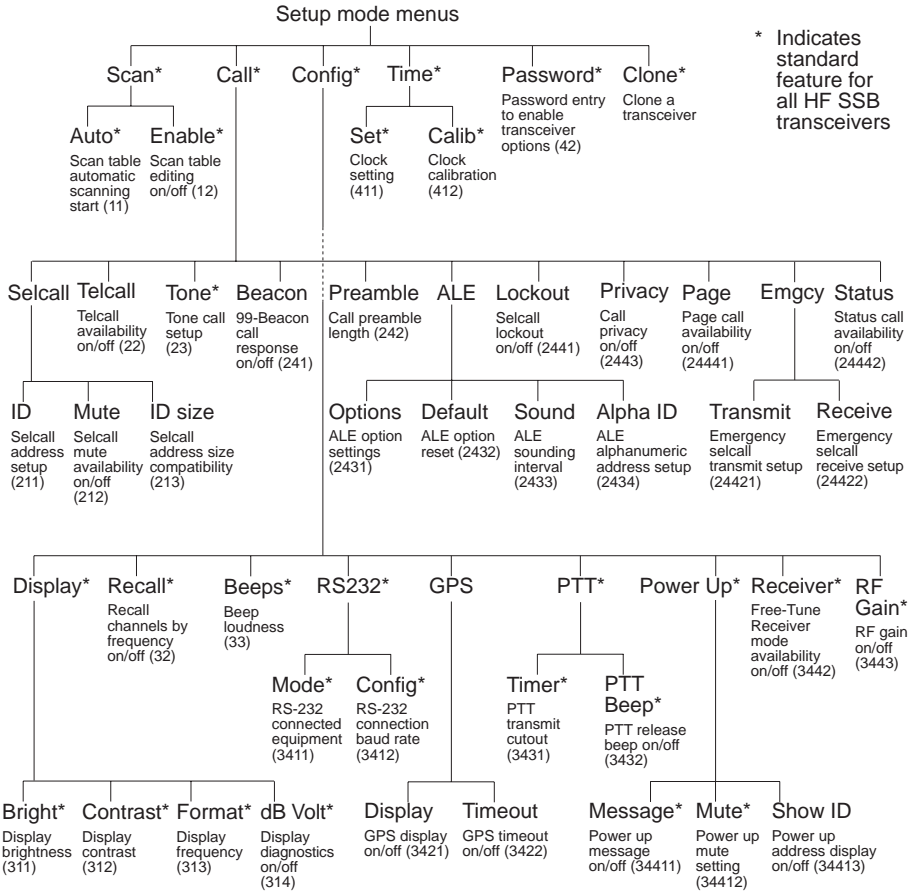

Figure 4.1 The Setup mode tree

If you are comfortable using menus and selecting menu options, you can refer to the Setup mode tree instead of entering setup codes to access each procedure. This allows you to use Setup mode by directly following the guidance shown on the transceiver display.

Each branch in the menu tree shows:

- the name of the menu item shown on the display
- the name in small print of the equivalent procedure in this manual, if any, for this menu item
- the setup code in parentheses.

To navigate around the Setup mode tree, use front panel button:

- **F2** to select a highlighted menu option and advance down the tree
- **F1** to go back up the tree to the previous menu.

For example, you could branch down to the **Power Up** menu and view each of the **Power Up** menu options, **Message**, **Mute** and **Show ID**, in turn making any changes to settings as necessary.



5 Setup procedures—part 1

This chapter contains the following Setup mode procedures:

- ALE alphanumeric address setup (5-2)
- ALE option reset (5-4)
- ALE option settings (5-6)
- ALE sounding interval (5-13)
- Beep loudness* (5-15)
- Call preamble length (5-17)
- Call privacy on/off (5-19)
- Clock calibration* (5-21)
- Clock setting* (5-23)
- Clone a transceiver* (5-28).

* indicates a standard procedure available in all HF SSB series transceivers (see *Chapter 4, Using Setup mode procedures*).

ALE alphanumeric address setup



Setup code 2434

This procedure is used to set the alphanumeric address of your transceiver.

This address is needed in ALE (Automatic Link Establishment) calls that use alphanumeric station addresses. An alphanumeric address is either a 7–15 digit number or an address containing one or more of the characters ‘A–Z’, ‘@’ and ‘?’.

Your alphanumeric address is valid for all channels and ALE scan tables.

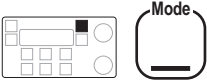
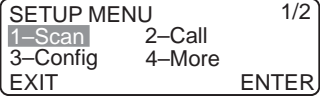
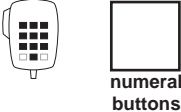
To set your alphanumeric address:

Action	Notes
<p>1. Repeatedly press</p>  <p>until you see the display for Setup mode.</p>	<p>The display shows:</p> 
<p>2. Enter 2434</p> 	<p>Example of the display:</p> 

Action

Notes

3. To enter your alphanumeric address, select each character using

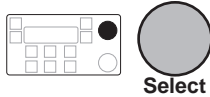

and move between characters using

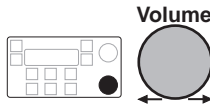

Enter up to 15 '0-9', 'A-Z', '@' and '?' characters. Any space is automatically replaced by '0'.

To clear an existing address, press

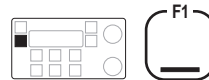

4. To save your change, press

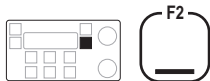

The display shows:

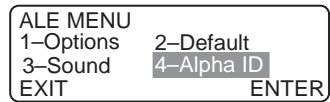

5. To return to Channel mode, press three times

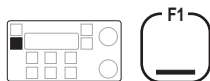

Example of the display:





ALE option reset

Setup code 2432

This procedure is used to reset 9 of the 17 ALE option settings 0–16 to their factory values.

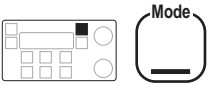
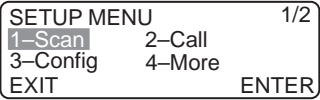
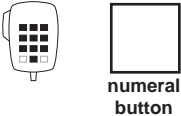
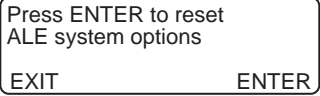
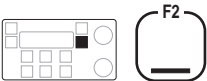
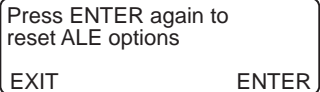
To reset the ALE option settings:

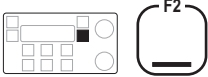
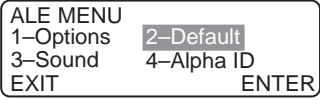
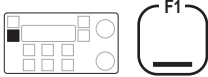
Action	Notes
<p>1. Repeatedly press</p>  <p>until you see the display for Setup mode.</p>	<p>The display shows:</p> 
<p>2. Enter 2432</p> 	<p>The display shows:</p> 
<p>3. Press</p> 	<p>The display shows:</p> 

Action	Notes
<p>4. To confirm resetting, press</p> 	<p>The transceiver beeps after resetting all ALE options.</p> <p>The display shows:</p> 
<p>5. To return to Channel mode, press three times</p> 	<p>Example of the display:</p> 



ALE option settings

Setup code 2431

This procedure is used to change how the Automatic Link Establishment (ALE) controller works.

There are 17 ALE system settings numbered 0–16. These settings control ALE call performance and do not usually require changing. You can change nine. The remaining eight are not displayed since their values are fixed.

Setting No.	Description
0	Sounding On/Off
2	Channel Quality Decay Time
3	Sounding Signal Length
5	BER Threshold
6	Golay Threshold
7	Error Threshold
11	ALE Silent Mode
13	Call Retry Limit
14	Channel Quality Averaging

For further information, this manual should be read in conjunction with the *9300 ALE controller user guide* (Codan part number 15-04046).

Sounding On/Off (ALE option 0)

This ALE option switches on or off sounding.

When sounding is switched off, your transceiver no longer sends or receives ALE sounding signals. For correct ALE operation, you should leave sounding on all the time.

If ALE Silent Mode (ALE option 11) is switched on, the Sounding On/Off option setting is ignored and your station does not send or receive ALE sounding signals. To set the sounding interval, see *ALE Sounding Interval* on page 5-13.

Channel Quality Decay Time (ALE option 2)

This ALE option sets the artificial decay time for the record of channel quality that is stored in the channel quality table in ALE controller memory.

You can switch off decay or set a decay time in the range 1–8 hours.

For example, switching the sounding off and setting a decay time of four hours would result in the record of a perfect channel (100% channel quality) decaying to an unusable channel (0% channel quality) over a period of four hours.

Sounding Signal Length (ALE option 3)

This ALE option sets the length in seconds of the sounding transmission for each channel in the scan group.

When an ALE station sends sounding signals, a separate signal is transmitted for each channel in the scan group. The ALE station sends these signals sequentially. The total length of the sounding transmission is the product of the sounding signal length and the number of channels.

For example, if the sounding signal length is set to 10 seconds and the scan group contains seven channels, the ALE station takes 70 seconds to complete sounding transmission.

The maximum setting of the sounding signal length is 100 seconds.

Bit Error Rate (BER) Threshold (ALE option 5)

This ALE option sets the value of the BER Threshold used in BER testing.

You can set a value in the range 0–48.

BER testing is a method of error detection for ALE word transmission. ALE stations send and receive ALE link controlling information in blocks of data called ALE words. An ALE word consists of a 3-bit preamble and a 21-bit data field.

The result of BER error testing is used in the process of determining whether or not the ALE link can be established using the selected channel.

The higher the BER value of a transmitted ALE word, the greater the error. A BER value of 0 indicates perfect reception of an ALE word. The maximum BER value of 48 indicates that all bits of the ALE word were bad.

If a received ALE word contains more errors than the BER Threshold, the ALE controller rejects the word. The lower you set the BER Threshold, the greater the likelihood of rejecting words with errors.

Golay Threshold (ALE option 6)

This ALE option sets the value of the Golay Threshold used in Golay testing.

You can set a value in the range 0–4.

Golay testing is an additional method of error detection for ALE word transmission. The result of Golay error testing is used in the process of determining whether or not the ALE link can be established using the selected channel.

The higher the Golay value calculated for a received ALE word, the greater the error.

If a received ALE word contains more errors than the Golay Threshold, the ALE controller rejects the word. The lower you set the Golay Threshold, the greater the likelihood of rejecting words with errors.

Error Threshold (ALE option 7)

This ALE option sets the maximum number of sequentially received bad ALE words that are allowed before the ALE controller decides that the quality of the current channel is too poor to establish an ALE link. A bad word is a word that has exceeded either the BER or Golay Threshold.

You can set a value in the range 0–4.

If the test fails during the process of establishing the ALE link, the call aborts and the transceiver returns to Scan mode.

ALE Silent Mode (ALE option 11)

This ALE option switches on or off ALE Silent mode.

When ALE Silent mode is switched off, the station runs as a normal ALE station.

When ALE Silent mode is switched on, the station will not:

- recognise any incoming ALE calls
- send or receive sounding signals even if Sounding On/Off (ALE option 0) is switched on.

You can still send ALE calls in ALE Silent mode.

Call Retry Limit (ALE option 13)

This ALE option controls the number of times the ALE station tries to establish an ALE link using each channel in turn from the scan group.

You can set 99 for no limit to the number of tries or a value in the range 0–98.

On each selected channel, two attempts are made to establish a link before trying the next preferred channel, where two more attempts are made and so on, until all channels in the scan table have been tried (unless a link is established).

The sequence is then repeated dependent upon the number set in the Call Retry Limit.

If a link is not established, the display shows LINK FAILED accompanied by error beeps. Retry duration can be up to one minute per channel.

Channel Quality Averaging (ALE option 14)

This ALE option sets the method used to update an existing channel quality value stored in ALE controller memory when the new channel quality reading is worse than the stored value.





You can replace old values with:

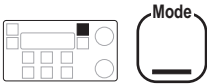
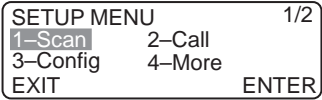
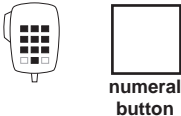
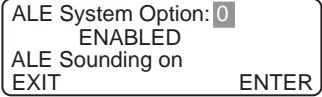

- new readings
- different weighted averages of the old values and new readings.

Averaging reduces the effect that one bad reading may have on a perfect channel. If a new reading is better than an old value, the old value is replaced by the new reading.

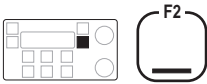
Changing an ALE option setting

To change an ALE option setting:

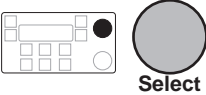
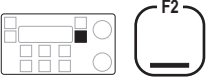
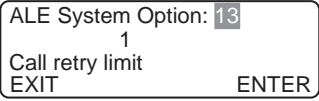
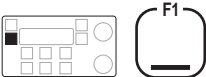
Action	Notes
<p>1. Repeatedly press</p>  <p>until you see the display for Setup mode.</p>	<p>The display shows:</p> 
<p>2. Enter 2431</p> 	<p>Example of the display:</p> 
<p>3. To find the ALE option you want to change, rotate</p> 	<p>The name of the option setting is shown on the third line of each display.</p> <p>You can only display and change nine of the 17 ALE options (numbered 0–16).</p>
<p>4. To select this ALE option, press</p> 	<p>For example, option 13 (Call Retry Limit) looks like this:</p> 

Action	Notes
<p>5. To change the setting, rotate</p> 	
<p>6. To save your change, press</p> 	<p>Example of the display:</p> 
<p>7. Do you want to change another ALE option?</p> <p>Yes ➤ Return to Step 3.</p> <p>No ➤ Step 8.</p>	
<p>8. To return to Channel mode, press four times</p> 	<p>Example of the display:</p> 



ALE sounding interval

Setup code 2433

This procedure is used to change the ALE sounding time interval.





ALE stations repeatedly send sounding signals to determine how good each channel is for transmission. The ALE sounding interval is the time between signal transmissions.

You can select:

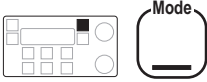
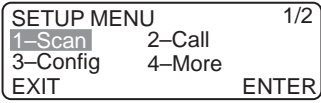
- 30 Mins
- 45 Mins
- 1 Hour
- 2 Hours
- 4 Hours
- 8 Hours
- 16 Hours.

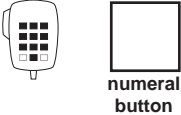
To change the ALE sounding time interval:

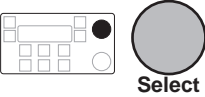
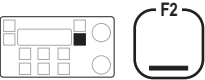
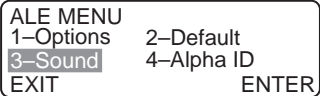
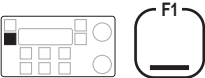
Action	Notes
<p>1. Repeatedly press</p> 	<p>The display shows:</p> 
<p>until you see the display for Setup mode.</p>	

Action	Notes
<p>2. Enter 2433</p> 	<p>Example of the display:</p> 
<p>3. To change the ALE sounding interval, rotate</p> 	<p>Select a time in the range 30 minutes to 16 hours.</p>
<p>4. To save your change, press</p> 	<p>The display shows:</p> 
<p>5. To return to Channel mode, press three times</p> 	<p>Example of the display:</p> 



Beep loudness

Setup code 33 (standard procedure)





This procedure is used to change the volume of beeps made by the transceiver.

You can select:

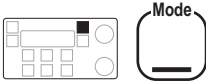
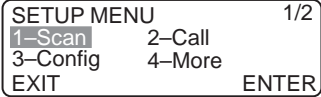
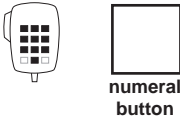
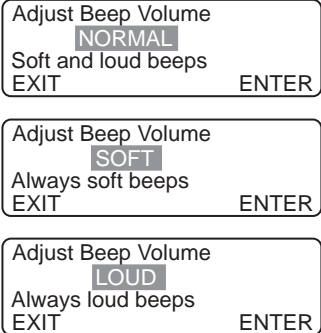
- NORMAL (error beeps loud and acceptance beeps soft)
- SOFT (all beeps soft)
- LOUD (all beeps loud).

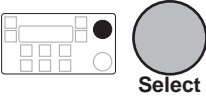
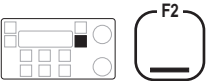
To change the beep loudness:

Action	Notes
<p>1. Repeatedly press</p>  <p>until you see the display for Setup mode.</p>	<p>The display shows:</p> 
<p>2. Enter 33</p> 	<p>The display looks like one of the following:</p> 

Action	Notes
<p>3. To switch between NORMAL, SOFT and LOUD, rotate</p> 	<p>Select:</p> <ul style="list-style-type: none"> • NORMAL if you want loud error beeps and soft acceptance beeps • SOFT if you always want soft beeps • LOUD if you always want loud beeps.
<p>4. To save your change, press</p> 	<p>The display shows:</p> 
<p>5. To return to Channel mode, press twice</p> 	<p>Example of the display:</p> 



Call preamble length

Setup code 242

This procedure is used to set the length of the preamble transmitted at the start of a selective call.

The preamble is part of the coded message structure that is transmitted when you send a selective call. The preamble allows the receiving station sufficient time to scan to the selected channel and recognise the incoming call.

You can set the preamble for:



- **Selcall** (for all types of selective call except ALE calls)
- **ALE** (for all types of selective call including ALE calls).

If you do not have an ALE controller, you should use the **Selcall** preamble. If your station has an ALE controller and you want to be able to send ALE calls, you should use the **ALE** preamble.

ALE calls need a longer preamble than other types of selective call. The **Selcall** preamble lasts six seconds. The **ALE** preamble lasts 12 seconds. Setting the **ALE** preamble does not stop you from sending other types of selective call but increases the initial call response time.

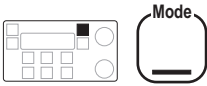
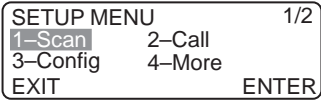
To change the preamble length:

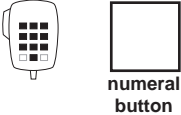
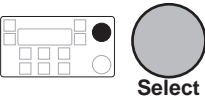
Action	Notes
<p>1. Repeatedly press</p>  <p>until you see the display for Setup mode.</p>	<p>The display shows:</p> 

Action	Notes
<p>2. Enter 242</p> 	<p>The display shows:</p> <div style="border: 1px solid black; padding: 5px; margin-bottom: 10px;"> Setup Call Preamble SELCALL Selcall Preamble EXIT ENTER </div> <p>or</p> <div style="border: 1px solid black; padding: 5px;"> Setup Call Preamble ALE ALE Preamble EXIT ENTER </div>
<p>3. To switch between SELCALL and ALE, rotate</p> 	<p>Select:</p> <ul style="list-style-type: none"> • SELCALL if you are not using an ALE controller • ALE if you are using an ALE controller to send calls.
<p>4. To save your change, press</p> 	<p>The display shows:</p> <div style="border: 1px solid black; padding: 5px;"> CALL MENU 2/4 1-Beacon 2-Preamble 3-ALE 4-More EXIT ENTER </div>
<p>5. To return to Channel mode, press twice</p> 	<p>Example of the display:</p> <div style="border: 1px solid black; padding: 5px;"> Geneva Switzerland USB HI 149 2040 CALL Rx. Pwr </div>



Call privacy on/off





Setup code 2443

This procedure is used to limit the stations that can receive your transmissions of GPS, page and status call information.

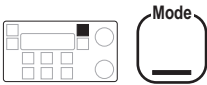
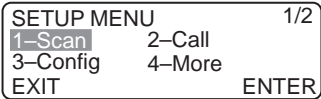
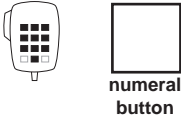
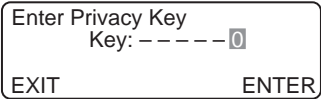
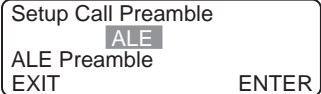
You switch on call privacy by setting a privacy key (a number up to six digits). This restricts the stations that can receive your information to those using an identical privacy key.

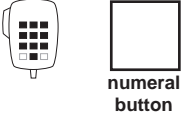
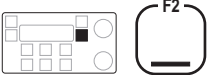
To switch on or off call privacy:

Action	Notes
<p>1. Repeatedly press</p>  <p>until you see the display for Setup mode.</p>	<p>The display shows:</p> 
<p>2. Enter 2443</p> 	<p>If privacy is unset, the privacy key is shown as 0 like this:</p>  <p>If privacy is set, the privacy key is hidden like this:</p> 

Action	Notes
<p>3. Enter the privacy key</p> 	<p>Enter up to six digits (these are displayed).</p> <p>To switch off call privacy, enter 0 for the privacy key.</p>
<p>4. To save your change, press</p> 	<p>The display shows:</p> 
<p>5. To return to Channel mode, press twice</p> 	<p>Example of the display:</p> 



Clock calibration

Setup code 412 (standard procedure)

This procedure is used to calibrate the transceiver clock against an external standard.



The clock is used for timing incoming selective calls recorded in call memory.

You can adjust the running of the clock by changing the number of seconds that the clock gains or loses each month. The calibration range is -150 to +310 seconds/month in steps of 10 (approximate values).

The first time you calibrate the clock, set the value to zero seconds/month. Over a period of a few months, see if the clock gains or loses time and recalibrate as necessary.

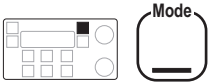
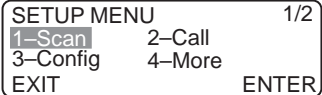
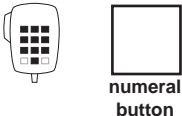
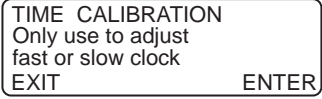
To calibrate the clock:

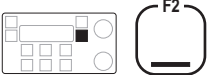
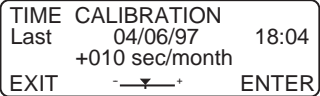
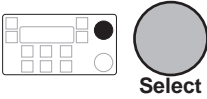
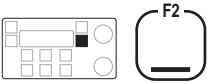
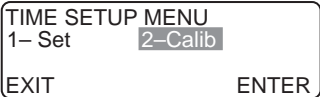
Action	Notes
<p>1. Repeatedly press</p>  <p>until you see the display for Setup mode.</p>	<p>The display shows:</p> 
<p>2. Enter 412</p> 	<p>The display shows:</p> 

Action	Notes
<p>3. Press</p> 	<p>The display shows the day and time that the calibration was last set:</p> 
<p>4. To change the calibration setting, rotate</p> 	<p>The calibration range is -155 to +310 seconds/month in steps of 10.</p> <p>As you change the value, the slider moves at the bottom of the screen—as displayed above.</p>
<p>5. To save your change, press</p> 	<p>The display shows:</p> 
<p>6. To return to Channel mode, press twice</p> 	<p>Example of the display:</p> 



Clock setting

Setup code 411 (standard procedure)





This procedure is used to set the time and date of the transceiver clock.

The time is always shown in 24 hour format. The clock is used for timing incoming selective calls recorded in call memory.

To change the clock setting, you must complete the procedure. If you exit the procedure before the end, all changes are lost.

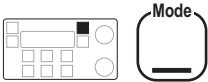
The clock stops during the procedure. When you complete the procedure, it restarts using the new settings.

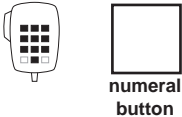
To set the clock:

Action	Notes
<p>1. Repeatedly press</p>  <p>until you see the display for Setup mode.</p>	<p>The display shows:</p> 
<p>2. Enter 411</p> 	<p>The clock stops running. Example of the display:</p> 

Action

Notes

3. Enter the hour if you want to change the hour

Use 24-hour format. For example, enter 18 for 6pm.



4. Press

Example of the display:

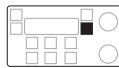

TIME SETUP		
16:01	D/M/Y	03/05/97
Enter minutes		
EXIT	ENTER	

5. Enter the minutes if you want to change the minutes

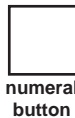







6. Press

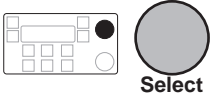
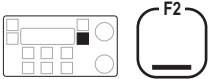

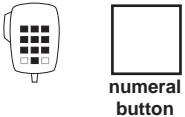
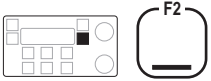
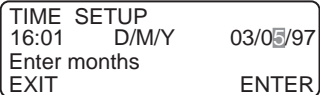
Example of the display:

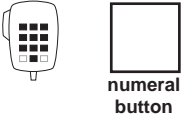
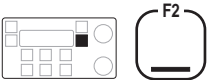

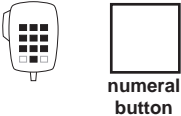
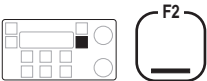
TIME SETUP		
16:01	D/M/Y	03/05/97
Select date format		
EXIT	ENTER	

Action	Notes
<p>7. To switch between D/M/Y and M/D/Y date formats, rotate</p> 	<p>Select:</p> <ul style="list-style-type: none"> • D/M/Y for day/month/year • M/D/Y for month/day/year.
<p>8. Press</p> 	<p>Example of the display:</p> 
<p>9. Enter the day for the D/M/Y format if you want to change the day (or month for the M/D/Y format)</p> 	
<p>10. Press</p> 	<p>Example of the display:</p> 

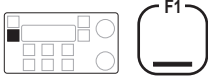
Action	Notes
<p>11. Enter the month for the D/M/Y format if you want to change the month (or day for the M/D/Y format)</p> 	
<p>12. Press</p> 	<p>Example of the display:</p> 
<p>13. Enter the last two digits of the year if you want to change the year</p> 	<p>For example, enter 97 for 1997.</p>
<p>14. To save all changes to the time and date, press</p> 	<p>The clock restarts at the time the F2 button is pressed. The display shows:</p> 

Action	Notes
<p>15. If you are setting the clock for the first time, calibrate the clock.</p>	<p>Set calibration to zero seconds/month. See <i>Clock calibration</i> on page 5-21.</p>
<p>16. To return to Channel mode, press twice</p>	<p>Example of the display:</p>
	



Clone a transceiver (standard procedure)

This procedure is used to copy the settings from one transceiver to another by a process called cloning. Cloning transceivers allows you to set up several transceivers that all work in exactly the same way.

You clone transceivers by connecting the microphone socket of the transceiver, which is already set up, to the microphone socket of a transceiver that is to become a clone.

You can obtain the cable required for this procedure from an authorised Codan dealer (Codan part no. 08-05138-001).

Except for the PIN, selcall group information and alphanumeric address, the cloning procedure overwrites all settings in the transceiver that you are copying to.

To clone a transceiver:

Action	Notes
1. Use the Cloning cable to join the microphone sockets of the two transceivers.	
2. Switch on both transceivers.	

Action**Notes**

3. On the master transceiver you are cloning from, repeatedly press

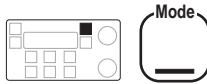

until you see the display for Setup mode.

The display shows:

```

SETUP MENU                               1/2
1-Scan      2-Call
3-Config    4-More
EXIT                               ENTER
  
```

4. Select 4-More by rotating

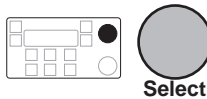

5. Press

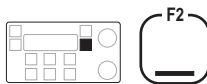

The display shows:

```

SETUP MENU                               2/2
1-Time      2-Password
3-Clone    4-More
EXIT                               ENTER
  
```

6. Select 3-Clone by rotating

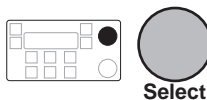

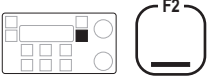
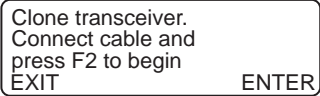
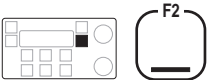
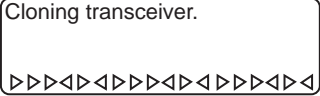
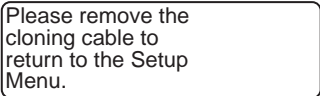
Action	Notes
<p>7. Press</p> 	<p>The display shows:</p> 
<p>8. To start the transfer of information, press</p> 	<p>The display shows:</p>  <p>After about two minutes, cloning finishes and the master transceiver beeps twice. The display shows:</p> 
<p>9. Disconnect the cable and switch off both transceivers.</p>	



6 Setup procedures—part 2

This chapter contains the following Setup mode procedures:

- Display brightness* (6-2)
- Display contrast* (6-4)
- Display diagnostics on/off* (6-6)
- Display frequency* (6-8)
- Emergency selcall receive setup (6-11)
- Emergency selcall transmit setup (6-15)
- Free-Tune Receiver mode availability on/off* (6-19)
- GPS display on/off (6-21)
- GPS timeout on/off (6-23).

* indicates a standard procedure available in all HF SSB series transceivers (see *Chapter 4, Using Setup mode procedures*).

Display brightness



Setup code 311 (standard procedure)

This procedure is used to change the brightness of the display.

You can also adjust the brightness of the display using the **On/Off** button on the control panel (refer to the *HF SSB transceiver user guide, Chapter 3, Adjusting the display brightness*).

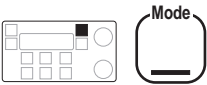
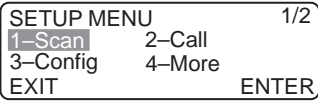
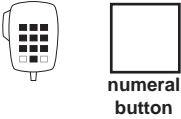
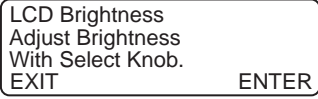
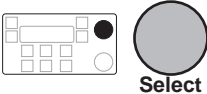
To adjust the brightness of the display:

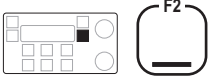
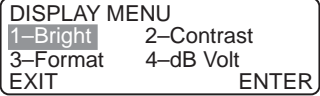
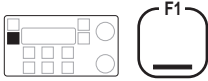
Action	Notes
<p>1. Repeatedly press</p>  <p>until you see the display for Setup mode.</p>	<p>The display shows:</p> 
<p>2. Enter 311</p> 	<p>The display shows:</p> 
<p>3. To adjust the brightness, rotate</p> 	

Action	Notes
<p>4. To save your change, press</p> 	<p>The display shows:</p> 
<p>5. To return to Channel mode, press three times</p> 	<p>Example of the display:</p> 





Display contrast



Setup code 312 (standard procedure)

This procedure is used to change the contrast of the display.

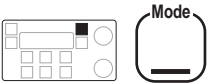
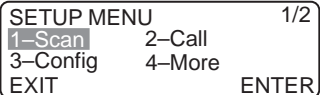
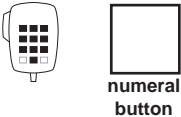
You can also adjust the contrast of the display using the **On/Off** button on the control panel (refer to the *HF SSB transceiver user guide, Chapter 3, Adjusting the display contrast*).

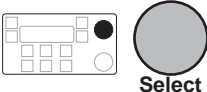
To adjust the contrast of the display:

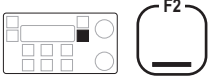
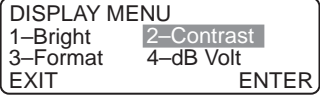
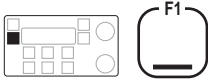
Action	Notes
<p>1. Repeatedly press</p>  <p>until you see the display for Setup mode.</p>	<p>The display shows:</p> 
<p>2. Enter 312</p> 	<p>The display shows:</p> 
<p>3. To adjust the contrast, rotate</p> 	

Action	Notes
<p>4. To save your change, press</p> 	<p>The display shows:</p> 
<p>5. To return to Channel mode, press three times</p> 	<p>Example of the display:</p> 



Display diagnostics on/off

Setup code 314 (standard procedure)



This procedure is used to switch on or off the display of diagnostic information about your transceiver.



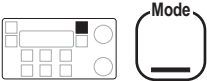
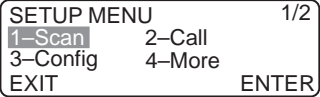
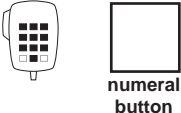

Diagnostic information is useful for service technicians who want to monitor transceiver operation. The information is displayed on the top line of the screen in Channel mode. It is updated every 250 milliseconds.

The information consists of:

- while receiving—receive signal strength (μV and $\text{dB } \mu\text{V}$) and battery voltage
- while tuning—the SWR and battery voltage.

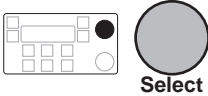
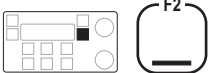
To switch on or off the display of diagnostic information:

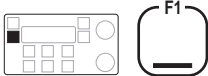
Action	Notes
<p>1. Repeatedly press</p>  <p>until you see the display for Setup mode.</p>	<p>The display shows:</p> 
<p>2. Enter 314</p> 	<p>The display shows:</p>  <p>or</p> 

Action	Notes
<p>3. To switch between ENABLED and DISABLED, rotate</p> 	<p>Select:</p> <ul style="list-style-type: none"> • ENABLED if you want to display diagnostic information • DISABLED if you do not want to display diagnostic information.
<p>4. To save your change, press</p> 	<p>The display shows:</p> 
<p>5. To return to Channel mode, press three times</p> 	<p>Example of the display:</p> 



Display frequency

Setup code 313 (standard procedure)

This procedure is used to set how the frequency is displayed for each channel.

You can select:

- RX/TX
- INHIBIT
- RX ONLY.

For two-frequency simplex channels, the RX/TX setting displays the transmit frequency above the receive frequency. An arrow on the screen moves from the receive frequency to the transmit frequency during transmission. For other channels where the transmit and receive frequencies are the same, this setting displays the single frequency.



The INHIBIT setting displays no frequency for any channel.

The RX ONLY setting displays the frequency in use, whether single frequency or two-frequency simplex, which changes to the transmit frequency during transmission.

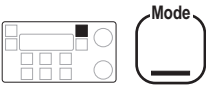
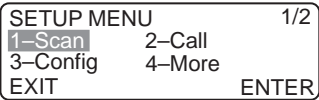
To change how the channel frequency is displayed:

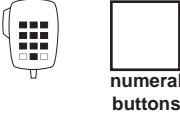
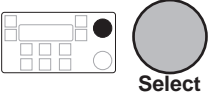
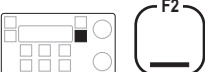
Action	Notes
<p>1. Repeatedly press</p>  <p>until you see the display for Setup mode.</p>	<p>The display shows:</p> 

Action	Notes
<p data-bbox="236 217 445 240">2. Enter 313</p> 	<p data-bbox="684 217 1001 276">The display shows one of the following:</p> <div data-bbox="689 296 1009 392" style="border: 1px solid black; padding: 5px;"> <p data-bbox="695 300 897 323">Freq. display format</p> <p data-bbox="757 323 835 347">RX/TX</p> <p data-bbox="695 347 904 371">Show Tx and Rx freq</p> <p data-bbox="695 371 1003 395">EXIT ENTER</p> </div> <div data-bbox="689 413 1009 509" style="border: 1px solid black; padding: 5px;"> <p data-bbox="695 416 897 440">Freq. display format</p> <p data-bbox="757 440 846 464">INHIBIT</p> <p data-bbox="695 464 904 488">Show no frequencies</p> <p data-bbox="695 488 1003 512">EXIT ENTER</p> </div> <div data-bbox="689 529 1009 625" style="border: 1px solid black; padding: 5px;"> <p data-bbox="695 533 897 557">Freq. display format</p> <p data-bbox="757 557 857 580">RX ONLY</p> <p data-bbox="695 580 882 604">Show Rx freq. only</p> <p data-bbox="695 604 1003 628">EXIT ENTER</p> </div>
<p data-bbox="236 707 583 766">3. To switch between the settings, rotate</p> 	<p data-bbox="684 707 759 730">Select:</p> <ul data-bbox="684 754 975 1010" style="list-style-type: none"> <li data-bbox="684 754 975 850">• RX/TX to display both transmit and receive frequencies <li data-bbox="684 866 975 930">• INHIBIT to display no frequencies <li data-bbox="684 946 975 1010">• RX ONLY to display receive frequency only.
<p data-bbox="236 1090 568 1149">4. To save your change, press</p> 	<p data-bbox="684 1090 893 1114">The display shows:</p> <div data-bbox="689 1134 1009 1230" style="border: 1px solid black; padding: 5px;"> <p data-bbox="695 1137 860 1161">DISPLAY MENU</p> <p data-bbox="695 1161 944 1185">1-Bright 2-Contrast</p> <p data-bbox="695 1185 932 1209">3-Format 4-dB Volt</p> <p data-bbox="695 1209 1003 1233">EXIT ENTER</p> </div>

Action	Notes
<p data-bbox="182 215 542 276">5. To return to Channel mode, press three times</p> <div data-bbox="288 312 493 376">A schematic diagram of the radio's control panel. On the right side, there is a large, rounded rectangular button labeled 'F1'. To its left is a smaller control panel with several buttons and a small display area.</div>	<p data-bbox="631 215 956 244">Example of the display:</p> <div data-bbox="631 261 956 360">A rectangular display window showing the following information: 'Geneva Switzerland' at the top, 'USB HI' below it, a large frequency '149 2040' in the center, and 'CALL Rx. Pwr' at the bottom.</div>



Emergency selcall receive setup

Setup code 24422

This procedure is used to set up the transceiver for receiving emergency selcalls.

You can select:





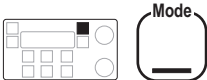
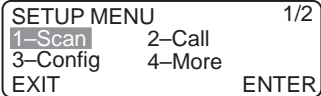

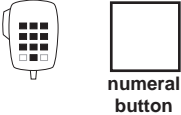
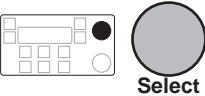
- **DISABLED** if you do not want to receive emergency selcalls
- **RECEIVE-ALL** if you want to receive all emergency selcalls on channels scanned by the transceiver
- **SELECTIVE** if you only want to receive emergency selcalls to your address and up to two additional addresses.

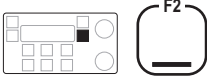
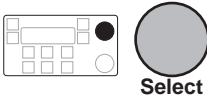
To set up how you receive emergency selcalls:

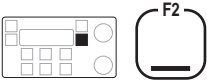
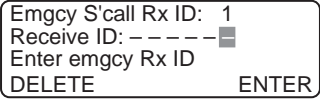
Action	Notes
<p>1. Repeatedly press</p>  <p>until you see the display for Setup mode.</p>	<p>The display shows:</p> 

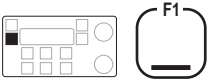
Action	Notes
<p>2. Enter 24422</p> 	<p>The display looks like one of the following:</p> <div data-bbox="636 293 956 389" style="border: 1px solid black; padding: 5px;"> <p>Emgcy S'call Receive DISABLED Don't receive emgcys EXIT ENTER</p> </div> <div data-bbox="636 411 956 507" style="border: 1px solid black; padding: 5px;"> <p>Emgcy S'call Receive RECEIVE-ALL Receive ALL emgcys EXIT ENTER</p> </div> <div data-bbox="636 529 956 625" style="border: 1px solid black; padding: 5px;"> <p>Emgcy S'call Receive SELECTIVE Only selected emgcys EXIT ENTER</p> </div>
<p>3. To switch between DISABLED, RECEIVE-ALL and SELECTIVE, rotate</p> 	<p>Select:</p> <ul style="list-style-type: none"> • DISABLED to receive no emergency selcalls • RECEIVE-ALL to receive all emergency selcalls on channels scanned by the transceiver • SELECTIVE to receive emergency selcalls to your address and up to two additional addresses.

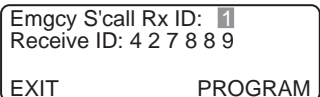
Action	Notes
<p>4. Press</p> 	<p>If you selected DISABLED or RECEIVE-ALL, the display shows:</p> <div data-bbox="688 325 1009 421" style="border: 1px solid black; padding: 5px;"> <p>EMGCY S'CALL MENU 1-Transmit 2-Receive EXIT ENTER</p> </div>
<p>5. Did you select SELECTIVE and do you want to set up extra addresses?</p> <p>Yes ➤ Step 6. No ➤ Step 11.</p>	<p>If you selected SELECTIVE, the display shows:</p> <div data-bbox="688 544 1009 639" style="border: 1px solid black; padding: 5px;"> <p>Emgcy S'call Rx ID: 1 Receive ID: ----- EXIT PROGRAM</p> </div> <p>SELECTIVE gives you the option of setting two other addresses for receiving emergency selcalls in addition to your address.</p>
<p>6. To select one of the two additional addresses, rotate</p> 	<p>Example of the display:</p> <div data-bbox="688 1051 1009 1147" style="border: 1px solid black; padding: 5px;"> <p>Emgcy S'call Rx ID: 1 Receive ID: ----- EXIT PROGRAM</p> </div>

Action	Notes
<p>7. Press</p> 	<p>Example of the display:</p> 
<p>8. Enter the address</p> 	<p>To clear an existing address, press</p> 
<p>9. Press</p> 	<p>Example of the display:</p> 
<p>10. Do you want to set up the other additional address?</p> <p>Yes ➤ Return to Step 6.</p> <p>No ➤ Step 11.</p>	
<p>11. To return to Channel mode, press three times</p> 	<p>Example of the display:</p> 



Emergency selcall transmit setup

Setup code 24421



This procedure is used to set up the transceiver for sending emergency selcalls.

The transceiver sends an emergency call when you press the **Emgcy Call** button on the control panel if you have used this procedure to set up the address to call.



You can set up:

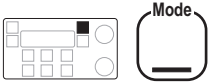
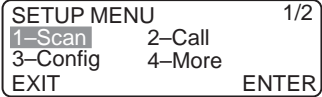

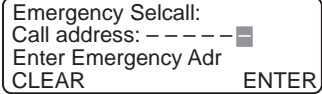
- the address to call
- up to four emergency channels.

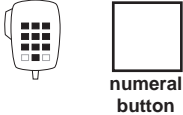
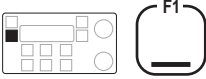
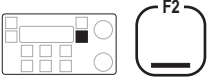
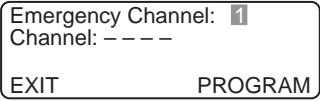
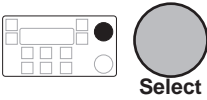
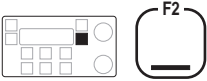
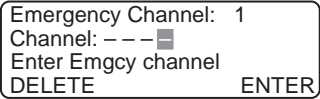
To set up the address to call and the channel to use when sending an emergency selcall:

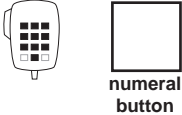
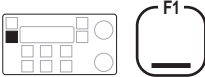
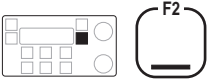
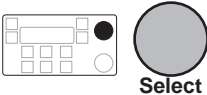
Action	Notes
<p>1. Repeatedly press</p>  <p>until you see the display for Setup mode.</p>	<p>The display shows:</p> 
<p>2. Enter 24421</p> 	<p>Example of the display:</p> 

Action	Notes
<p>3. Enter the address of the station to call in an emergency selcall</p> 	<p>To clear an existing address, press</p> 
<p>4. To save the address, press</p> 	<p>Example of the display:</p> 
<p>5. To select one of the four emergency channels, rotate</p> 	<p>Select any channel number 1 to 4.</p>
<p>6. Press</p> 	<p>Example of the display:</p> 

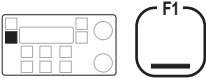
Action	Notes
<p>7. Enter the channel number for this emergency channel</p> 	<p>The transceiver error beeps if the channel:</p> <ul style="list-style-type: none"> • does not exist • is a receive-only channel. <p>To clear an existing channel, press</p> 
<p>8. Press</p> 	<p>Example of the display for channel 19:</p> <pre> Emergency Channel: 1 Channel: 19 USB Select sideband EXIT ENTER </pre>
<p>9. To switch between USB and LSB sideband settings (if both available), rotate</p> 	<p>Select:</p> <ul style="list-style-type: none"> • USB for upper sideband • LSB for lower sideband.
<p>10. To save your setting, press</p> 	<p>Example of the display:</p> <pre> Emergency Channel: 1 Channel: 19 USB EXIT PROGRAM </pre>

Action	Notes
<p>11. Do you want to set up another emergency channel?</p> <p>Yes ➤ Return to Step 5.</p> <p>No ➤ Step 12.</p>	
<p>12. To return to Channel mode, press four times</p> 	<p>Example of the display:</p> 





Free-Tune Receiver mode availability on/off



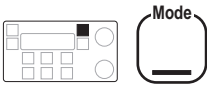
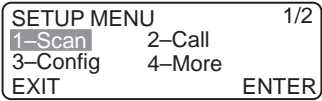
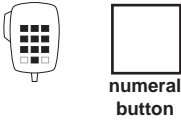

Setup code 3442 (standard procedure)

This procedure is used to switch on or off the availability of Free-Tune Receiver mode.

Free-Tune Receiver mode allows you to tune the receiver to any frequency in its operating frequency range.

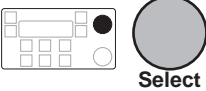
To switch on or off the availability of Free-Tune Receiver mode:

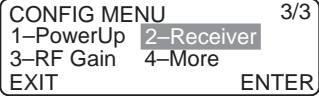
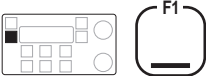
Action	Notes
<p>1. Repeatedly press</p>  <p>until you see the display for Setup mode.</p>	<p>The display shows:</p> 
<p>2. Enter 3442</p> 	<p>The display shows:</p>  <p>or</p> 

Action	Notes
<p>3. To switch between ENABLED and DISABLED, rotate</p> 	<p>Select:</p> <ul style="list-style-type: none"> • ENABLED if you want to be able to tune the transceiver to any receive frequency • DISABLED if you only want to use pre-programmed channels.
<p>4. To save your change, press</p> 	<p>The display shows:</p> 
<p>5. To return to Channel mode, press twice</p> 	<p>Example of the display:</p> 



GPS display on/off





Setup code 3421

This procedure is used to switch on or off the display of the Global Positioning System (GPS) location of your transceiver.

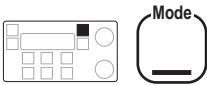
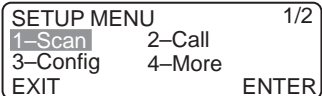
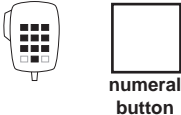
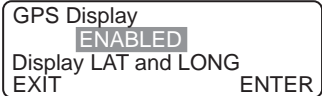
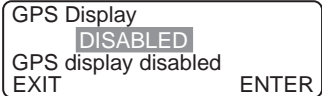
Your transceiver needs to be connected to a GPS receiver.

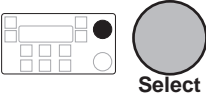
To switch on or off the displaying of GPS information:

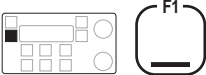
Action	Notes
<p>1. Repeatedly press</p>  <p>until you see the display for Setup mode.</p>	<p>The display shows:</p> 
<p>2. Enter 3421</p> 	<p>The display shows:</p>  <p>or</p> 

Action	Notes
<p>3. To switch between ENABLED and DISABLED, rotate</p> 	<p>Select:</p> <ul style="list-style-type: none"> • ENABLED if you want to display GPS latitude and longitude • DISABLED if you do not want to display GPS information.
<p>4. To save your change, press</p> 	<p>The display shows:</p> 
<p>5. To return to Channel mode, press three times</p> 	<p>Example of the display:</p> 



GPS timeout on/off

Setup code 3422

This procedure is used to switch on or off the GPS timeout warning.





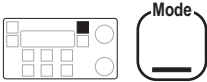
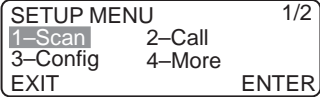

When GPS timeout is switched on, the transceiver beeps if it does not receive GPS information within the set time.

You can select:

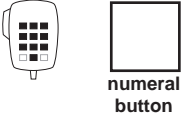
- 5 mins
- 10 mins
- 15 mins
- 20 mins
- 35 mins
- OFF (no error beep).

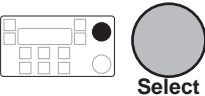
To switch on or off GPS timeout:

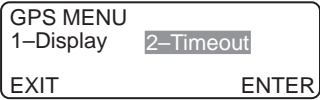
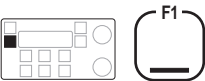
Action	Notes
<p>1. Repeatedly press</p>  <p>until you see the display for Setup mode.</p>	<p>The display shows:</p> 

Action	Notes
<p>2. Enter 3422</p> 	<p>If GPS timeout is switched off, the display shows:</p>  <p>If GPS timeout is switched on, the current programmed time setting is displayed.</p>
<p>3. To change the timeout setting, rotate</p> 	<p>Select:</p> <ul style="list-style-type: none"> • OFF • a time in the range 5–35 minutes.
<p>4. To save your change, press</p> 	<p>The display shows:</p> 
<p>5. To return to Channel mode, press three times</p> 	<p>Example of the display:</p> 



7 Setup procedures—part 3

This chapter contains the following Setup mode procedures:

- Page call canned message setup (7-2)
- Password entry to enable transceiver options* (7-5)
- Power up message on/off* (7-10)
- Power up mute setting* (7-13)
- Power up address display on/off (7-16)
- PTT release beep on/off* (7-18)
- PTT transmit cutout* (7-20)
- Recall channels by frequency on/off* (7-22)
- RF gain on/off* (7-24)
- RS-232 connected equipment* (7-26)
- RS-232 connection baud rate* (7-29).

* indicates a standard procedure available in all HF SSB series transceivers (see *Chapter 4, Using Setup mode procedures*).



Page call canned message setup

Setup code 24441

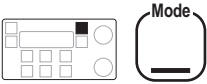
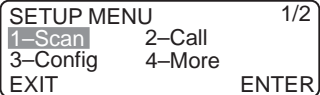
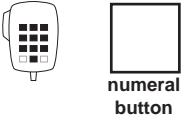
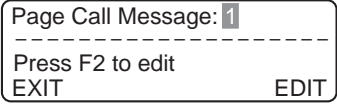
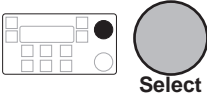

This procedure is used to prepare and store up to three messages ready for sending in a page call.

The message length can be up to 64 characters.

To prepare a canned message:

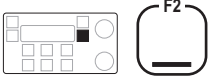
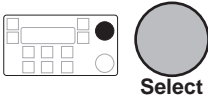
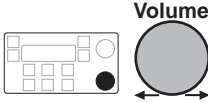
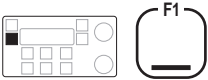
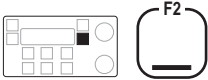
Action	Notes
<p>1. Repeatedly press</p>  <p>until you see the display for Setup mode.</p>	<p>The display shows:</p> 
<p>2. Enter 24441</p> 	<p>The message number is shown in the top right position of the display:</p> 
<p>3. To select a different canned message, rotate</p> 	<p>Example of canned message 3:</p> 

Action	Notes
<p>4. To edit this message, press</p> 	<p>Example of canned message 3:</p> <div style="border: 1px solid black; padding: 5px;"> <p>Page Call Message: 3 Edit page message CLEAR PROGRAM</p> </div>
<p>5. To enter the message, select each character using</p>  <p>and move between characters using</p> 	<p>Enter up to 64 characters.</p> <p>To clear any existing text, press</p> 
<p>6. To save your change, press</p> 	<p>Example of preparing the message 'Call me':</p> <div style="border: 1px solid black; padding: 5px;"> <p>Page Call Message: 3 Call me ----- Press F2 to edit EXIT EDIT</p> </div>
<p>7. Do you want to prepare another canned message?</p> <p>Yes ➤ Return to Step 3.</p> <p>No ➤ Step 8.</p>	

Action	Notes
<p data-bbox="182 217 572 276">8. To return to Channel mode, press three times</p> 	<p data-bbox="631 217 956 245">Example of the display:</p> 



Password entry to enable transceiver options

Setup code 42 (standard procedure)

This procedure is used to:

- display your transceiver ID
- enable transceiver options that are built into the transceiver
- delete your PIN if you have forgotten it.

By using passwords, you can purchase additional features for your transceiver without the need to return the unit to your Codan agent.

You obtain passwords from your Codan agent. There is a separate password for each transceiver option. Passwords are unique to your transceiver. You cannot use your transceiver's passwords with a different transceiver.

Enabling transceiver options

You can enable a transceiver option using a password.

After you have enabled an option, you may need to use other Setup mode procedures to enter settings that control the option.

You can remove an option previously enabled by repeating the procedure and entering the password again.

To enable a transceiver option:

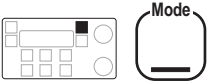
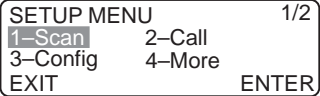
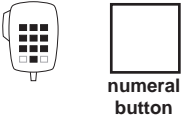
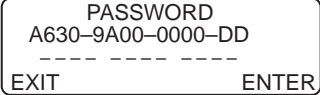
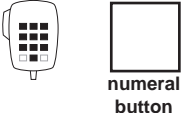
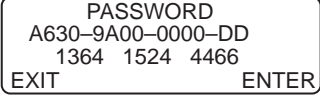
Action	Notes
<p>1. Repeatedly press</p>  <p>until you see the display for Setup mode.</p>	<p>The display shows:</p> 
<p>2. Enter 42</p> 	<p>The display shows your transceiver 14-digit ID, for example:</p> 
<p>3. Contact your Codan agent and request the password for the transceiver option you want to enable.</p>	<p>The Codan agent will ask you for personal identification and your transceiver ID.</p>
<p>4. Enter the password</p> 	<p>Example of the display:</p> 

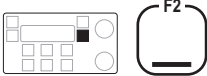
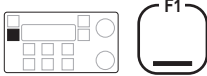



Action	Notes
<p data-bbox="236 217 426 240">5. Press</p> 	<p data-bbox="684 217 1039 336">If the password is incorrect, the transceiver beeps and switches off after displaying this for three seconds:</p> <div data-bbox="689 357 1009 453" style="border: 1px solid black; padding: 5px;"> <pre> PASSWORD INVALID A630-9A00-0000-DD ----- - 1 2 3 EXIT ENTER </pre> </div> <p data-bbox="684 499 1039 624">If the password is correct, the display shows the option as now enabled (for example, the GPS option):</p> <div data-bbox="689 643 1009 738" style="border: 1px solid black; padding: 5px;"> <pre> PASSWORD A630-9A00-0000-DD GPS Enabled EXIT ENTER </pre> </div>
<p data-bbox="236 818 599 879">6. To return to Channel mode, press</p> 	<p data-bbox="684 818 946 847">Example of the display:</p> <div data-bbox="689 866 1009 962" style="border: 1px solid black; padding: 5px;"> <pre> Geneva Switzerland USB HI CALL 149 2040 Pwr Rx. </pre> </div>

Deleting a PIN

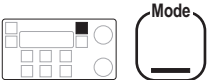
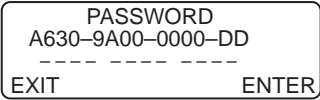
If the transceiver is set up with a PIN but you cannot remember it, you will not be able to use the transceiver. You will need to obtain the PIN Deletion password from your Codan agent. This password allows you to delete the PIN when you switch on the transceiver.

To delete a forgotten PIN:

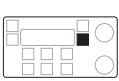
Action	Notes
<p>1. Switch on the transceiver.</p>	<p>The display shows:</p> 
<p>2. Press</p> 	<p>The display shows your transceiver 14-digit ID:</p> 
<p>3. Contact your Codan agent and request the PIN deletion password.</p>	<p>You will need this ID when you contact your Codan agent.</p> <p>Pressing the Mode button again returns you to the PIN entry screen.</p> <p>The Codan agent will ask you for personal identification and your transceiver ID.</p>

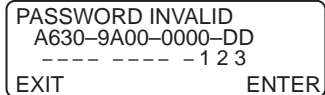
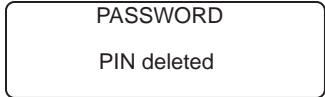
Action	Notes
<p>4. Enter the PIN deletion password</p>	
  <p>numeral button</p>	
<p>5. Press</p>	<p>If the password is incorrect, the transceiver beeps and switches off after displaying this for three seconds:</p>
 	
	<p>If the password is correct, the transceiver enters Channel mode after displaying this for 10 seconds:</p>
	
	<p>To set up a new PIN, see <i>Chapter 9, PIN setup</i>.</p>







Power up message on/off

Setup code 34411 (standard procedure)

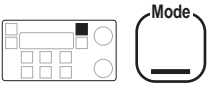
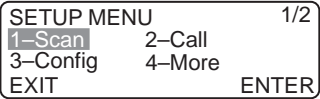
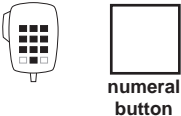
This procedure is used to set up a message that is displayed for several seconds when the transceiver is first switched on.

To set or cancel a power up message:

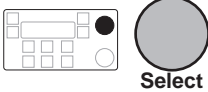
Action	Notes
<p>1. Repeatedly press</p>  <p>until you see the display for Setup mode.</p>	<p>The display shows:</p> 
<p>2. Enter 34411</p> 	<p>Example of the display:</p>  <p>or</p> 

Action	Notes
<p>3. To switch between ENABLED and DISABLED, rotate</p> 	<p>Select:</p> <ul style="list-style-type: none"> • ENABLED if you want to display a message when you switch on the transceiver • DISABLED if you do not want to display a message when you switch on the transceiver.
<p>4. To save your change, press</p> 	<p>If you selected ENABLED, the display shows:</p> <div data-bbox="689 687 1009 788" style="border: 1px solid black; padding: 5px;"> <pre>Power Up Message █----- Modify message CLEAR ENTER</pre> </div> <p>If you selected DISABLED, the display shows:</p> <div data-bbox="689 906 1009 1007" style="border: 1px solid black; padding: 5px;"> <pre>POWER UP MENU 1-Message 2-Mute 3-Show ID EXIT ENTER</pre> </div>
<p>5. Did you select ENABLED to display a power up message?</p> <p>Yes ➤ Step 6.</p> <p>No ➤ Step 8.</p>	

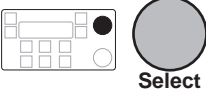
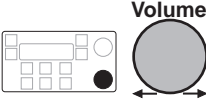
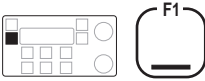
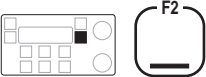
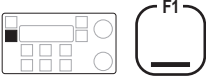
Action	Notes
<p data-bbox="182 217 553 308">6. To enter the message, select each character using</p>  <p data-bbox="314 456 516 515">and move between characters using</p> 	<p data-bbox="631 217 916 244">Enter up to 20 characters.</p> <p data-bbox="631 264 916 323">To clear any existing text, press</p> 
<p data-bbox="182 719 546 778">7. To save your change, press</p> 	<p data-bbox="631 719 841 746">The display shows:</p> <div data-bbox="636 762 956 858" style="border: 1px solid black; padding: 5px;"> <p>POWER UP MENU 1-Message 2-Mute 3-Show ID EXIT ENTER</p> </div>
<p data-bbox="182 967 572 1026">8. To return to Channel mode, press three times</p> 	<p data-bbox="631 967 891 994">Example of the display:</p> <div data-bbox="636 1010 956 1106" style="border: 1px solid black; padding: 5px;"> <p>Geneva Switzerland USB HI CALL 149 2040 Rx. Pwr</p> </div>



Power up mute setting

Setup code 34412 (standard procedure)



This procedure is used to select the initial mute setting that is used when the transceiver is first switched on.

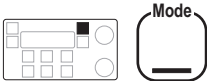
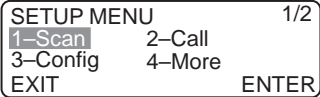

You can select:

- NO MUTE
- AUDIO MUTE
- SELCALL MUTE (if selcall mute availability is switched on, see *Chapter 8, Selcall mute availability on/off*).

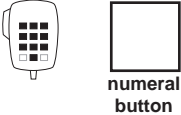
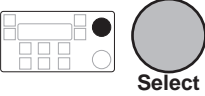
To change the initial mute setting:

Action	Notes
<p>1. Repeatedly press</p>  <p>until you see the display for Setup mode.</p>	<p>The display shows:</p> 

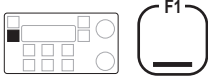
Action	Notes
<p>2. Enter 34412</p> 	<p>The display looks like one of the following:</p> <div data-bbox="636 296 956 392" style="border: 1px solid black; padding: 5px;"> <p>Mute Power Up NO MUTE EXIT ENTER</p> </div> <div data-bbox="636 416 956 512" style="border: 1px solid black; padding: 5px;"> <p>Mute Power Up AUDIO MUTE EXIT ENTER</p> </div> <div data-bbox="636 536 956 632" style="border: 1px solid black; padding: 5px;"> <p>Mute Power Up SELCALL MUTE EXIT ENTER</p> </div>
<p>3. To switch between the settings, rotate</p> 	<p>Select:</p> <ul style="list-style-type: none"> • NO MUTE if you want no muting on power switch on • AUDIO MUTE if you want voice muting on power switch on • SELCALL MUTE if you want selcall muting on power switch on.
<p>4. To save your change, press</p> 	<p>The display shows:</p> <div data-bbox="636 1174 956 1270" style="border: 1px solid black; padding: 5px;"> <p>POWER UP MENU 1-Message 2-Mute 3-Show ID EXIT ENTER</p> </div>

Action	Notes
5. To return to Channel mode, press three times	Example of the display:
	







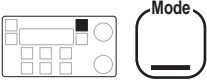
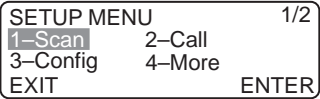
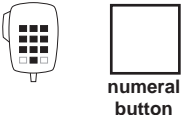

Power up address display on/off

Setup code 34413

This procedure is used to select whether or not your address, set up in selcall group 1, is briefly displayed when the transceiver is first switched on.

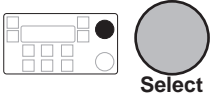
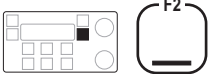
To switch on or off the display of the address:

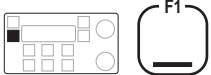
Action	Notes
<p>1. Repeatedly press</p>  <p>until you see the display for Setup mode.</p>	<p>The display shows:</p> 
<p>2. Enter 34413</p> 	<p>The display shows:</p>  <p>or</p> 

Action	Notes
<p>3. To switch between SHOW SELF ID and HIDE SELF ID, rotate</p> 	<p>Select:</p> <ul style="list-style-type: none"> • SHOW SELF ID if you want to display your address for several seconds when the transceiver is first switched on • HIDE SELF ID if you do not want to display your address.
<p>4. To save your change, press</p> 	<p>The display shows:</p> 
<p>5. To return to Channel mode, press three times</p> 	<p>Example of the display:</p> 





PTT release beep on/off







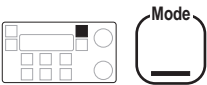
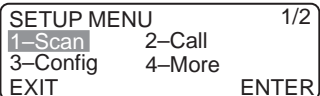
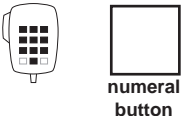

Setup code 3432 (standard procedure)

This procedure is used to switch on or off the PTT release beeping. The PTT release beep feature saves you from having to say ‘over’ every time you release the **PTT** button.

When you switch on PTT release beeping, the transceiver automatically indicates that you have finished talking by sending a beep every time you release the **PTT** button. You do not hear the beeps at your station.

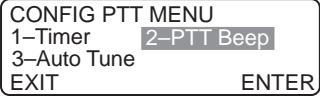
To switch on or off PTT release beeping:

Action	Notes
<p>1. Repeatedly press</p>  <p>until you see the display for Setup mode.</p>	<p>The display shows:</p> 
<p>2. Enter 3432</p> 	<p>The display shows:</p>  <p>or</p> 

Action	Notes
<p>3. To switch between ENABLED and DISABLED, rotate</p>  	<p>Select:</p> <ul style="list-style-type: none"> • ENABLED to make the transceiver beep when you release the PTT button • DISABLED to stop the transceiver beeping when you release the PTT button.
<p>4. To save your change, press</p>  	<p>The display shows:</p> 
<p>5. To return to Channel mode, press three times</p>  	<p>Example of the display:</p> 



PTT transmit cutout

Setup code 3431 (standard procedure)

This procedure is used to set the PTT transmit cutout time, preventing the transceiver from being left on in the transmit state by mistake.

If the transmit time exceeds the time set for PTT transmit cutout, the transceiver switches to receive and displays an error message.









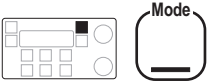
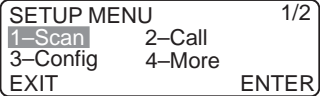

This cutout does not apply to any equipment connected to the **GP** connector.

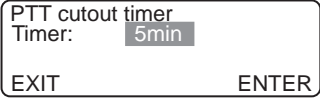
You can select:

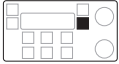
- OFF (transmission never cuts out)
- 5 mins
- 10 mins
- 15 mins
- 20 mins
- 35 mins.

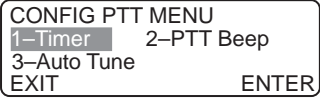
To set the PTT transmit cutout time:

Action	Notes
<p>1. Repeatedly press</p>  <p>until you see the display for Setup mode.</p>	<p>The display shows:</p> 

Action	Notes
<p>2. Enter 3431</p>   <p>numeral button</p>	<p>Example of the display:</p> 
<p>3. To set the cutout time, rotate</p>   <p>Select</p>	<p>Select:</p> <ul style="list-style-type: none"> • OFF • a time in the range 5–35 minutes.
<p>4. To save your change, press</p>   <p>F2</p>	<p>The display shows:</p> 
<p>5. To return to Channel mode, press three times</p>   <p>F1</p>	<p>Example of the display:</p> 







Recall channels by frequency on/off

Setup code 32 (standard procedure)

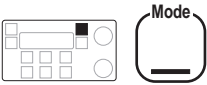
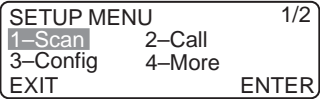
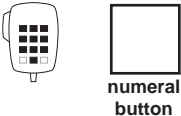
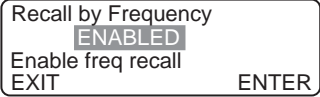
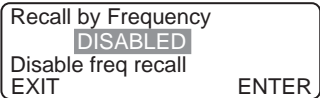
This procedure is used to select whether or not you can recall channels by frequency.

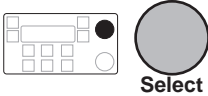
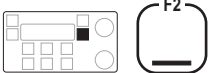
To switch on or off the recalling of channels by frequency:

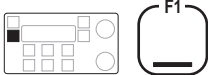
Action	Notes
<p>1. Repeatedly press</p>  <p>until you see the display for Setup mode.</p>	<p>The display shows:</p> 
<p>2. Enter 32</p> 	<p>The display shows:</p>  <p>or</p> 

Action	Notes
<p>3. To switch between ENABLED and DISABLED, rotate</p> 	<p>Select:</p> <ul style="list-style-type: none"> • ENABLED to allow channel recall by frequency as well as channel number • DISABLED to only allow channel recall by channel number.
<p>4. To save your change, press</p> 	<p>The display shows:</p> 
<p>5. To return to Channel mode, press twice</p> 	<p>Example of the display:</p> 





RF gain on/off



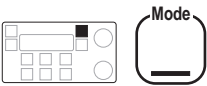
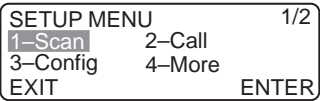
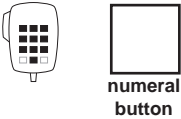

Setup code 3443 (standard procedure)

This procedure is used to switch on or off the RF gain. This changes the receive sensitivity of the transceiver.

Switch on RF gain for a mobile station or for an area where electrical interference is low. Switch off RF Gain for a base station that has large antennas or for an area where electrical interference is high.

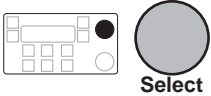
To switch on or off the RF gain:

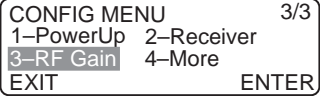
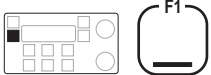
Action	Notes
<p>1. Repeatedly press</p>  <p>until you see the display for Setup mode.</p>	<p>The display shows:</p> 
<p>2. Enter 3443</p> 	<p>The display shows:</p>  <p>or</p> 

Action	Notes
<p>3. To switch between RF gain ON and OFF, rotate</p> 	<p>Select:</p> <ul style="list-style-type: none"> • ON for a mobile station or for an area where electrical interference is low • OFF for a base station or for an area where electrical interference is high.
<p>4. To save your change, press</p> 	<p>The display shows:</p> 
<p>5. To return to Channel mode, press twice</p> 	<p>Example of the display:</p> 



RS-232 connected equipment Setup code 3411 (standard procedure)

This procedure is used to identify the equipment connected to either the **RS-232** socket or **GP** connector on the transceiver rear panel.



Select:

- NONE (if nothing is connected)
- COMPUTER (if a computer is connected)
- GPS NMEA-0183 (if a GPS receiver is connected)
- 9300 ALE (if an ALE controller is connected).

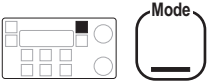
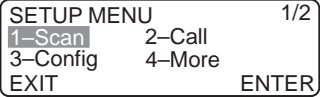
To change the setting for the equipment connected to the **RS-232** socket or **GP** connector:

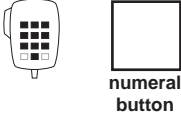
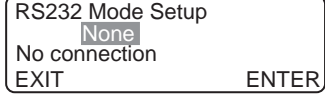
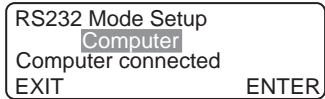
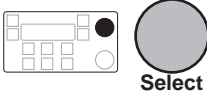
Action	Notes
<p>1. Repeatedly press</p>  <p>until you see the display for Setup mode.</p>	<p>The display shows:</p> 

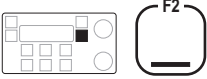
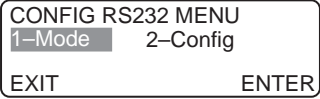
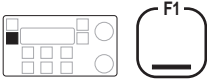
Action	Notes
<p data-bbox="236 217 488 240">2. Enter 3411</p> <div data-bbox="396 264 576 379">  </div>	<p data-bbox="684 217 893 240">The display shows:</p> <div data-bbox="684 264 1009 360">  </div> <p data-bbox="684 392 712 408">or</p> <div data-bbox="684 424 1009 523">  </div>
<p data-bbox="236 735 613 794">3. To switch between the settings, rotate</p> <div data-bbox="370 823 576 919">  </div>	<p data-bbox="684 735 759 759">Select:</p> <ul data-bbox="684 791 1009 1091" style="list-style-type: none"> <li data-bbox="684 791 941 842">• NONE if nothing is connected <li data-bbox="684 871 969 922">• COMPUTER if a computer is connected <li data-bbox="684 951 1005 1002">• GPS NMEA-0183 if a GPS receiver is connected <li data-bbox="684 1031 975 1082">• 9300 ALE if an ALE controller is connected.

Action	Notes
<p>4. To save your change, press</p> 	<p>The display shows:</p> 
<p>5. To return to Channel mode, press three times</p> 	<p>Example of the display:</p> 



RS-232 connection baud rate

Setup code 3412 (standard procedure)

This procedure is used to set the speed of information transfer for equipment connected to either the **RS-232** socket or **GP** connector on the transceiver rear panel.





You can select the following baud rates:

- 300
- 600
- 1200
- 2400
- 4800
- 9600.

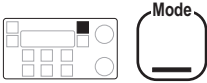
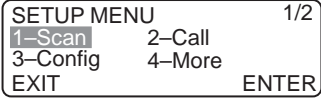
For a GPS receiver, the baud rate is usually 4800. For a computer or an ALE controller, the baud rate is usually 9600.

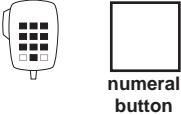
To set the baud rate for the **RS-232** socket and **GP** connector:

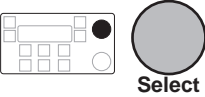
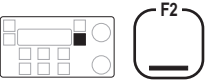
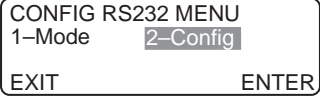
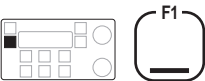
Action	Notes
<p>1. Repeatedly press</p> 	<p>The display shows:</p> 
<p>until you see the display for Setup mode.</p>	

Action	Notes
<p>2. Enter 3412</p> 	<p>Example of the display:</p> 
<p>3. To select the baud rate, rotate</p> 	<p>Select the same baud rate used by the connected equipment in the range 300–9600.</p>
<p>4. To save your change, press</p> 	<p>The display shows:</p> 
<p>5. To return to Channel mode, press three times</p> 	<p>Example of the display:</p> 



8 Setup procedures—part 4

This chapter contains the following Setup mode procedures:

- Scan table automatic scanning start* (8-2)
- Scan table editing on/off* (8-4)
- Selcall address setup (8-6)
- Selcall address size compatibility (8-13)
- Selcall lockout on/off (8-16)
- Selcall mute availability on/off (8-18)
- Status call availability on/off (8-20)
- Telcall availability on/off (8-22)
- Tone call setup* (8-24)
- 99-beacon call response on/off (8-27).

* indicates a standard procedure available in all HF SSB series transceivers (see *Chapter 4, Using Setup mode procedures*).

Scan table automatic scanning start

Setup code 11 (standard procedure)

This procedure is used to set the time delay between finishing a call and resuming automatic scanning.



When you do not touch any button or knob for longer than this delay time, the transceiver automatically starts scanning.



If you have set up any of the three scan tables for ALE scanning, it uses the scan table last used in scanning. If you have not set up any scan table for ALE scanning, it uses scan table 1.

You can switch automatic scanning:

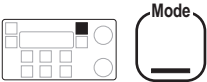
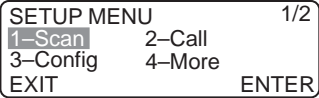
- off
- on with a 1–10 minute time delay.

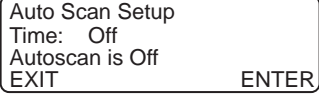
To switch on or off automatic scanning:

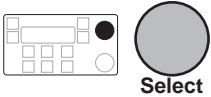
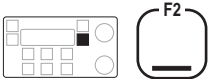
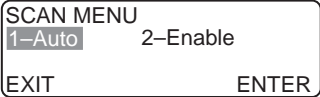
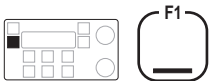
Action	Notes
<p>1. Repeatedly press</p>  <p>until you see the display for Setup mode.</p>	<p>The display shows:</p> 
<p>2. Enter 11</p>  <p>numeral button</p>	<p>Example of the display:</p> 

Action	Notes
<p>3. To change the automatic scanning setting, rotate</p> 	<p>Select:</p> <ul style="list-style-type: none"> • OFF • a delay in the range 1–10 minutes.
<p>4. To save your change, press</p> 	<p>The display shows:</p> 
<p>5. To return to Channel mode, press twice</p> 	<p>Example of the display:</p> 



Scan table editing on/off

Setup code 12 (standard procedure)









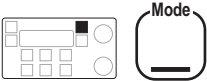
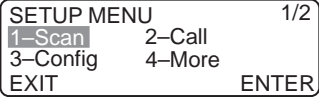



This procedure is used to switch on or off scan table editing.

After you have set up your scan tables, switching off scan table editing safeguards against accidentally deleting or modifying scan table information. For details on setting up scan tables, see *Chapter 3, Scan table creation*.

When scan table editing is switched off, you cannot set up, delete or modify any scan table. You can only use the transceiver's automatic scanning start feature if a scan table has already been set up (see *Scan table automatic scanning start* on page 8-2).

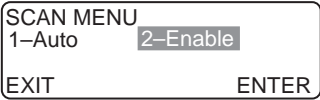
To switch on or off scan table editing:

Action	Notes
<p>1. Repeatedly press</p> 	<p>The display shows:</p> 
<p>until you see the display for Setup mode.</p>	

Action	Notes
<p>2. Enter 12</p>  	<p>The display shows:</p>  <p>or:</p> 
<p>3. To switch between ENABLED and DISABLED, rotate</p>  	<p>Select:</p> <ul style="list-style-type: none"> • ENABLED to switch on scan table editing • DISABLED to switch off scan table editing.
<p>4. To save your change, press</p>  	<p>The display shows:</p> 
<p>5. To return to Channel mode, press twice</p>  	<p>Example of the display:</p> 



Selcall address setup

Setup code 211

This procedure is used to set up addresses for any of your transceiver's five selcall groups S1–S5.

Having set up a selcall group, you can assign the group to any channel. This allows you to set up your transceiver with several own addresses so that you can operate in more than one network.

You can set up any selcall group. To find out the selcall group assigned to each channel in the transceiver, refer to the *HF SSB transceiver user guide, Chapter 3, Using View Channel Options mode*.

A selcall group for normal selective calling consists of:

- your address (self ID)
- an optional address to call (call address)
- the selcall type set to **Codan**
- an optional comment describing the selcall group.

Your address is the radio equivalent to the telephone number of your station. Do not use 00 or 99 as the last two digits since these addresses are reserved for sending group and 99-beacon calls.

Set the optional address to call if you want to restrict selective calls on all channels set up with this selcall group to one station (for example, a mobile station that only ever needs to call a base station). Otherwise, leave this address blank.

The selcall type describes the type of selcall group. For normal selective calling between stations, use the **Codan** selcall type. If you want to set up a selcall group for Radphone Direct Dialling (secure telcalls) use the **RDD** selcall type.



A selcall group for sending secure calls consists of:

- your address (self ID)
- the address to call (call address) left blank
- the selcall type set to RDD
- the RDD PIN
- an optional comment describing the selcall group for RDD use.

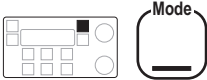
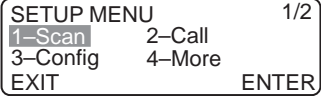
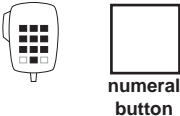
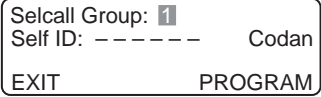

Setting up a selcall group

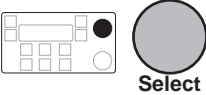
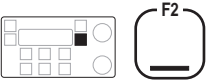
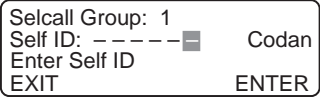
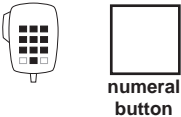
To set up a selcall group:

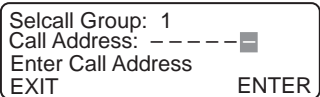

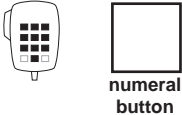
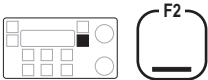
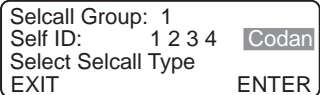
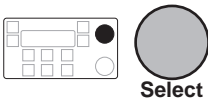
Action	Notes
<p>1. Repeatedly press</p>  <p>until you see the display for Setup mode.</p>	<p>The display shows:</p> 
<p>2. Enter 211</p> 	<p>Example of the display:</p> 

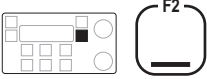
Action	Notes
<p>3. To select the selcall group, rotate</p> 	<p>Select one of the five selcall groups 1–5.</p>
<p>4. Press</p> 	<p>Example of the display:</p> 
<p>5. Enter your address (self ID)</p> 	<p>For an RDD selcall type, enter the address that the telephone company asked you to use as your address when sending RDD telcalls.</p>
<p>6. Press</p> 	<p>Example of the display:</p> 

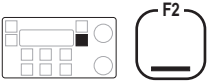
Action	Notes
<p>7. If you want to restrict calls on all channels set up with this selcall group to one station, enter the address of this station (call address)</p> 	<p>To cancel an existing address, enter 0.</p> <p>Leave this address blank if you want to be able to enter the address when sending the call.</p>
<p>8. Press</p> 	<p>Example of the display:</p> 
<p>9. To select the selcall type, rotate</p> 	<p>Select:</p> <ul style="list-style-type: none"> • Codan for normal selcalls • RDD for secure RDD telcalls.

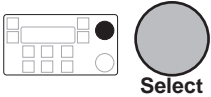
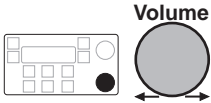
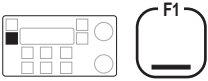
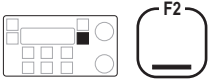
Action	Notes
<p>10. Press</p> 	<p>Example of the display for the Codan selcall type:</p> <div data-bbox="636 292 956 387" style="border: 1px solid black; padding: 5px;"> <pre>Selcall Group: 2 Self ID: 1 8 5 0 7 4 Codan █----- CLEAR ENTER</pre> </div> <p>Example of the display for the RDD selcall type:</p> <div data-bbox="636 507 956 603" style="border: 1px solid black; padding: 5px;"> <pre>Selcall Group: 1 PIN: ----- █ RDD Enter RDD PIN EXIT ENTER</pre> </div>
<p>11. Did you select the RDD selcall type?</p> <p>Yes ➤ Step 12.</p> <p>No ➤ Step 14.</p>	
<p>12. Enter your RDD PIN</p> 	
<p>13. Press</p> 	<p>Example of the display:</p> <div data-bbox="636 1198 956 1294" style="border: 1px solid black; padding: 5px;"> <pre>Selcall Group: 1 Self ID: 1 2 3 4 RDD █----- CLEAR ENTER</pre> </div>

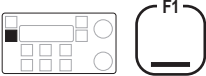
- | Action | Notes |
|---|---|
| <p>14. To enter a comment to describe this selcall group, select each character using</p>  <p>and move between characters using</p>  | <p>Enter up to 20 characters.</p> <p>To clear any existing text, press</p>  |
| <p>15. To save your changes for this selcall group, press</p>  | <p>Example of the display:</p> <div data-bbox="689 794 1009 890" style="border: 1px solid black; padding: 5px;"> <p>Selcall Group: 1
 Self ID: 1 2 3 4 RDD
 EXIT PROGRAM</p> </div> <p>or</p> <div data-bbox="689 962 1009 1058" style="border: 1px solid black; padding: 5px;"> <p>Selcall Group: 2
 Self ID: 1 2 3 4 Codan
 EXIT PROGRAM</p> </div> |
| <p>16. Do you want to set up another selcall group?</p> <p>Yes ➤ Return to Step 3.</p> <p>No ➤ Step 17.</p> | |

Action	Notes
<p data-bbox="183 215 561 276">17. To return to Channel mode, press four times</p> 	<p data-bbox="631 215 955 244">Example of the display:</p> 



Selcall address size compatibility

Setup code 213

This procedure is used to select how you communicate with stations that cannot use addresses longer than four digits.

You can select:



- 4-DIGIT-COMPATIBLE
- 6-DIGIT-ONLY.

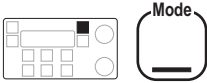
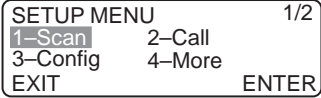

If some stations in your network are only capable of using 4-digit addresses and your address is longer than four digits, select **4-DIGIT-COMPATIBLE**. This allows other stations to call you by your last four digits. For example, if your address is 123456, you can be called on 3456 as well as 123456.

If all the stations in your network are capable of using 6-digit addresses, select **6-DIGIT-ONLY**. This ensures you can only be called by your full address. You will not receive unwanted calls by chance matching of the last four digits.

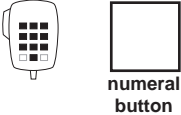
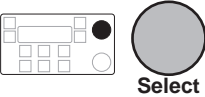
To set the address size compatibility:

Action	Notes
<p>1. Repeatedly press</p> 	<p>The display shows:</p> 
<p>until you see the display for Setup mode.</p>	

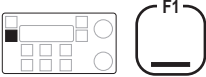
Action	Notes
<p>2. Enter 213</p> 	<p>The display shows:</p> <div style="border: 1px solid black; padding: 5px; margin-bottom: 10px;"> <p>S'call Compatibility 4-DIGIT-COMPATIBLE 4 digit interoperable EXIT ENTER</p> </div> <p>or</p> <div style="border: 1px solid black; padding: 5px;"> <p>S'call Compatibility 6-DIGIT-ONLY Only 6-digit calls EXIT ENTER</p> </div>
<p>3. To switch between the two settings, rotate</p> 	<p>Select:</p> <ul style="list-style-type: none"> • 4-DIGIT-COMPATIBLE if some stations in your network can not use 6-digit addresses • 6-DIGIT-ONLY if all stations in your network are capable of using 6-digit addresses.
<p>4. To save your change, press</p> 	<p>The display shows:</p> <div style="border: 1px solid black; padding: 5px;"> <p>SELCALL MENU 1-ID 2-Mute 3-ID size EXIT ENTER</p> </div>

Action	Notes
5. To return to Channel mode, press three times	Example of the display:
	



Selcall lockout on/off

Setup code 2441





This procedure is used to switch on or off selcall lockout.

Selcall lockout prevents you from sending selective calls if the transceiver detects that another station is already in the process of sending a selective call on the same channel. This reduces call interference between stations and increases the chance of success when your call is transmitted.

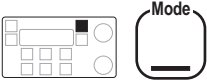
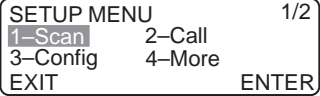
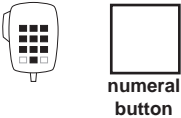
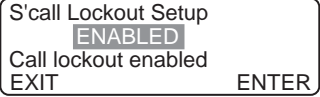
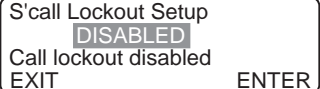
Selcall lockout does not apply to voice, tone or emergency calls.

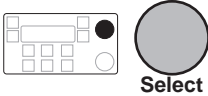
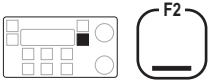
To switch on or off selcall lockout:

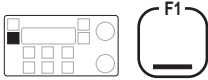
Action	Notes
<p>1. Repeatedly press</p>  <p>until you see the display for Setup mode.</p>	<p>The display shows:</p> 
<p>2. Enter 2441</p> 	<p>The display shows:</p>  <p>or</p> 

Action	Notes
<p data-bbox="236 217 577 304">3. To switch between ENABLED and DISABLED, rotate</p> 	<p data-bbox="684 217 759 240">Select:</p> <ul data-bbox="684 264 1037 536" style="list-style-type: none"> <li data-bbox="684 264 1037 392">• ENABLED to prevent selcalls being made if another station has initiated a selcall on this channel <li data-bbox="684 408 1037 536">• DISABLED to allow selcalls being made even if another station has initiated a selcall on this channel. <p data-bbox="684 576 1037 663">Selcall lockout does not apply to voice, tone or emergency calls.</p>
<p data-bbox="236 743 600 807">4. To save your change, press</p> 	<p data-bbox="684 743 893 767">The display shows:</p> 
<p data-bbox="236 991 600 1054">5. To return to Channel mode, press twice</p> 	<p data-bbox="684 991 941 1015">Example of the display:</p> 





Selcall mute availability on/off



Setup code 212

This procedure is used to switch on or off the availability of selcall mute on the control panel (the **S'Call Mute** button). When selcall mute availability is switched off, the selcall mute button is disabled.

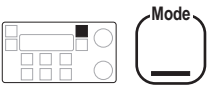
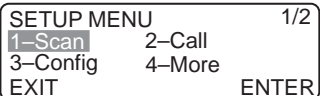
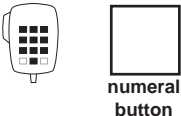
Switch off selcall mute availability if you never use selcalls. This will stop you selecting selcall mute by accident and missing incoming voice calls.

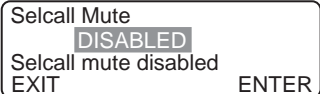
To switch on or off the availability of selcall mute:

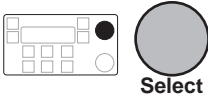
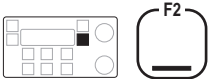
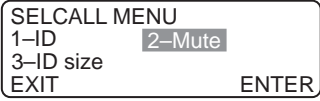
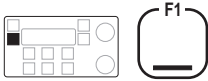
Action	Notes
<p>1. Repeatedly press</p>  <p>until you see the display for Setup mode.</p>	<p>The display shows:</p> 
<p>2. Enter 212</p>  <p>numeral button</p>	<p>The display shows:</p>  <p>or</p> 

Action	Notes
<p>3. To switch between ENABLED and DISABLED, rotate</p> 	<p>Select:</p> <ul style="list-style-type: none"> • ENABLED to make selcall mute available • DISABLED to disable selcall mute control.
<p>4. To save your change, press</p> 	<p>The display shows:</p> 
<p>5. To return to Channel mode, press three times</p> 	<p>Example of the display:</p> 







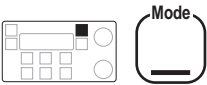
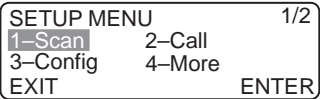
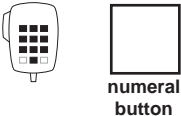

Status call availability on/off

Setup code 24442

This procedure is used to switch on or off the ability to send the three types of status call—remote diagnostics call, remote config call and user status call. It does not affect the ability to respond to incoming status calls.

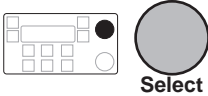
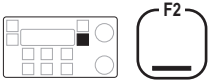
To switch on or off the ability to send status calls:

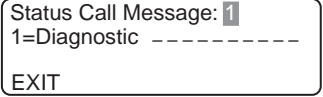
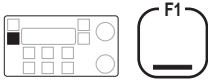
Action	Notes
<p>1. Repeatedly press</p>  <p>until you see the display for Setup mode.</p>	<p>The display shows:</p> 
<p>2. Enter 24442</p> 	<p>The display shows:</p>  <p>or</p> 

Action	Notes
<p>3. To switch between ENABLED and DISABLED, rotate</p> 	<p>Select:</p> <ul style="list-style-type: none"> • ENABLED to make status calls available • DISABLED to prevent status calls being made.
<p>4. To save your change, press</p> 	<p>The display shows:</p>  <p>or</p> 
<p>5. To return to Channel mode, repeatedly press</p>  <p>until you see the display for Channel mode.</p>	<p>Example of the display:</p> 





Telcall availability on/off



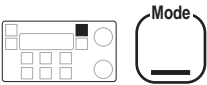
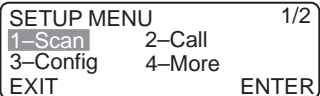
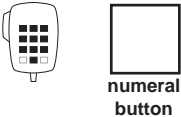

Setup code 22

This procedure is used to switch on or off the ability to send telcalls.

For information on telcalls, refer to the *HF SSB transceiver user guide, Chapter 4, Telcall*.

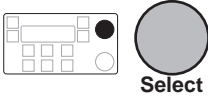
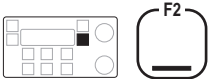
To switch on or off the ability to send telcalls:

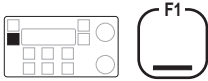
Action	Notes
<p>1. Repeatedly press</p>  <p>until you see the display for Setup mode.</p>	<p>The display shows:</p> 
<p>2. Enter 22</p> 	<p>The display shows:</p>  <p>or</p> 

Action	Notes
<p>3. To switch between ENABLED and DISABLED, rotate</p> 	<p>Select:</p> <ul style="list-style-type: none"> • ENABLED to make telcalls available • DISABLED to prevent telcalls being sent.
<p>4. To save your change, press</p> 	<p>The display shows:</p> 
<p>5. To return to Channel mode, press twice</p> 	<p>Example of the display:</p> 



Tone call setup

Setup code 23 (standard procedure)

This procedure is used to set up the high and low frequency pairs for any of the four tone call groups T1–T4.

Having set up a tone call group, you can assign the group to any channel.

You can set frequencies in the range 300–2,800Hz. If you want a tone call group to use a single frequency, set either the high or low frequency to 0Hz.

To set up a frequency pair for a tone call group:

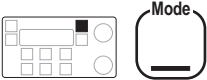
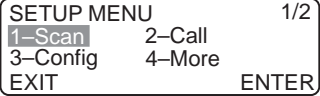
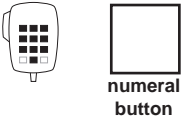
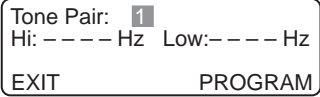
Action	Notes
<p>1. Repeatedly press</p>  <p>until you see the display for Setup mode.</p>	<p>The display shows:</p> 
<p>2. Enter 23</p>  <p>numeral button</p>	<p>Example of the display:</p> 

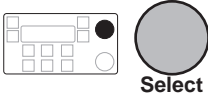
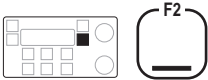
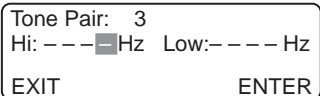
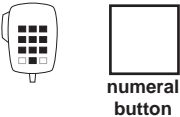
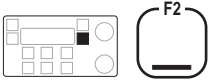
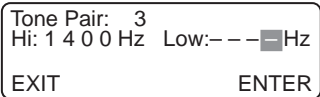
- | Action | Notes |
|---|--|
| <p>3. To select one of the four tone call groups, rotate</p> | |
|  | |
| <p>4. Press</p> | <p>Example of the display for tone call group T3:</p> |
|  |  |
| <p>5. Enter the high frequency</p> | <p>Set a frequency value in the range 300–2,800Hz.</p> |
|  | <p>This will cancel existing settings.</p> |
| <p>6. Press</p> | <p>For example, a high frequency of 1400Hz looks like this:</p> |
|  |  |

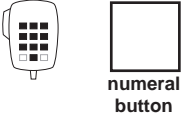
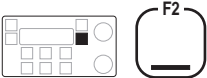
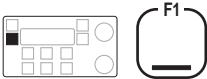
Action	Notes
<p>7. Enter the low frequency</p> 	<p>Set a value in the range 300–2,800Hz.</p> <p>To cancel an existing setting and leave the low frequency unset, enter 0.</p> <p>Leave the low frequency unset if you want this tone call group to use a single frequency.</p>
<p>8. To save your changes, press</p> 	<p>For example, a low frequency of 550Hz looks like this:</p> <div style="border: 1px solid black; padding: 5px; width: fit-content;"> <p>Tone Pair: 3 Hi: 1 4 0 0 Hz Low: 5 5 0 Hz</p> <p>EXIT PROGRAM</p> </div>
<p>9. Do you want to set up another tone call group?</p> <p>Yes ➤ Return to Step 3.</p> <p>No ➤ Step 10.</p>	
<p>10. To return to Channel mode, press three times</p> 	<p>Example of the display:</p> <div style="border: 1px solid black; padding: 5px; width: fit-content;"> <p>Geneva Switzerland USB HI 149 2040 CALL Rx. Pwr</p> </div>



99-beacon call response on/off



Setup code 241



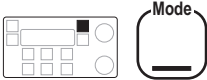
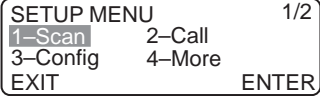
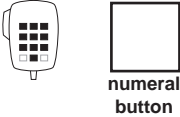

This procedure is used to switch on or off the ability to respond to received 99-beacon calls (selcalls ending in 99).

The transceiver responds to a 99-beacon call by transmitting a beacon signal of four long tones.

Switch 99-beacon call response on if there are earlier model transceivers in your network incapable of sending selective beacon calls. Note that your transceiver will respond to all incoming 99-beacon calls that match your address, excluding the last two digits.

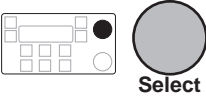
To switch on or off the ability to respond to 99-beacon calls:

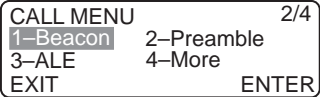
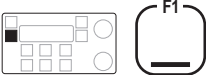
Action	Notes
<p>1. Repeatedly press</p>  <p>until you see the display for Setup mode.</p>	<p>The display shows:</p> 
<p>2. Enter 241</p> 	<p>Example of the display:</p>  <p>or</p> 

Action	Notes
<p>3. To switch between ENABLED and DISABLED, rotate</p> 	<p>Select:</p> <ul style="list-style-type: none"> • ENABLED to make your transceiver respond to received 99-beacon calls • DISABLED to prevent your transceiver responding to received 99-beacon calls.
<p>4. To save your change, press</p> 	<p>The display shows:</p> 
<p>5. To return to Channel mode, press twice</p> 	<p>Example of the display:</p> 



9 Link Setup mode

Link Setup mode allows you to access transceiver options that affect transceiver operation and security.

This chapter contains the following Link Setup procedures:

- Link Setup mode enter/exit (9-2)
- Antenna band or channel control (9-5)
- PIN setup (9-8)
- Setup mode availability on/off (9-11)
- Transceiver reset to factory settings (9-13).

If you make a mistake and want to exit half way through a Link Setup procedure, press the **F1** button on the control panel or **PTT** button on the microphone. This will return you to the start of Link Setup mode without making any changes.

Link Setup mode enter/exit

To use Link Setup mode, you have to take off the bottom cover of the transceiver and reposition an internal link.

Figure 9.1 shows the location of this link on the underneath side of the bottom printed circuit board.

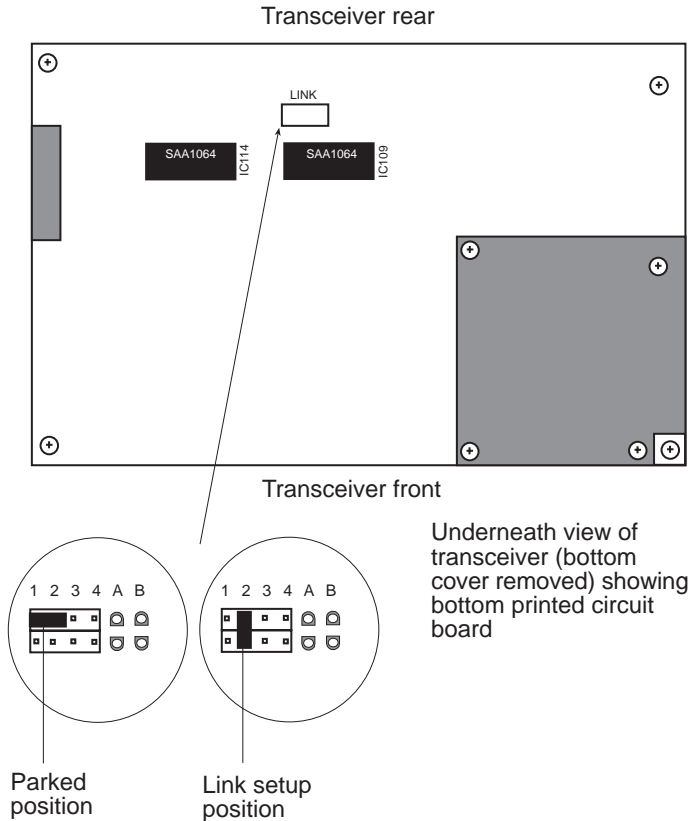

Figure 9.1 Moving the link for Link Setup mode

In normal transceiver operation, the link is in the parked position. In Link Setup mode, the link is in the link setup position.

The transceiver is muted and the **PTT** button is disabled in Link Setup mode.

To use Link Setup mode:

Action	Notes
1. Ensure the transceiver is switched off.	
2. Remove the bottom cover by removing the screws on either side and lifting the cover off.	The bottom cover usually has four rubber feet fitted.
3. Locate the link shown in Figure 9.1 and move it to the link setup position.	The link is a small connector that slides over two pins on the board. Pull it up gently to remove it.
4. Switch on the transceiver.	The display shows: <div data-bbox="689 1155 1009 1251" style="border: 1px solid black; padding: 5px; width: fit-content;"> <pre>LINK SETUP MENU 1-Pin 2-Inhibit 3-Antenna 4-Reset ENTER</pre> </div> The transceiver only detects a changed link position when the transceiver is first switched on.

	Action	Notes
5.	Follow one of the Link Setup procedures to make your changes.	See the Link Setup procedures later in this chapter. When all Link Setup procedures have been completed, continue with the next step in this procedure.
6.	Switch off the transceiver.	
7.	Return the link to the original parked position.	
8.	Replace the bottom cover and screws.	You are now ready to switch on the transceiver and continue normal operation.



Antenna band or channel control

This procedure is used to control the output of switching signals at the **Antenna Control** connector on the back panel of the transceiver.

You only need to use this procedure if you are using the transceiver to control equipment such as a multiple antenna installation or a switchable multi-frequency antenna. If you are using an automatic tuning antenna, any settings made by this procedure are ignored.





You can select:

- **CHANNEL** if you want the transceiver to control equipment according to the single frequency of the current channel
- **BAND SET 1** or **BAND SET 2** if you want the transceiver to control equipment according to the operating frequency band of the supporting equipment (for example, add-on high power linear amplifiers).

The following table provides the switching frequencies for the outputs. For further details, contact your Codan agent.

Outputs			Bandset 1 frequency ranges (MHz)	Bandset 2 frequency ranges (MHz)
4	2	1		
L	L	L	< 2	
L	L	H	2–2.99999	< 2
L	H	L	3–3.99999	2–2.99999
L	H	H	4–5.99999	3–4.99999
H	L	L	6–8.99999	5–7.99999
H	L	H	9–12.99999	8–12.99999
H	H	L	13–19.99999	13–19.99999
H	H	H	20–30	20–30

To change the antenna control setting:

Action	Notes
<p>1. Enter Link Setup mode.</p>	<p>See <i>Link Setup mode enter/exit</i> on page 9-2.</p> <p>The display shows:</p> <div data-bbox="636 432 956 528" style="border: 1px solid black; padding: 5px;"> <pre>LINK SETUP MENU 1-Pin 2-Inhibit 3-Antenna 4-Reset ENTER</pre> </div>
<p>2. Enter 3</p> <div data-bbox="342 659 524 775" style="display: flex; align-items: center;">   </div>	<p>The display shows one of the following:</p> <div data-bbox="636 691 956 786" style="border: 1px solid black; padding: 5px; margin-bottom: 10px;"> <pre>Antenna Control BAND SET 1 EXIT ENTER</pre> </div> <div data-bbox="636 810 956 906" style="border: 1px solid black; padding: 5px; margin-bottom: 10px;"> <pre>Antenna Control BAND SET 2 EXIT ENTER</pre> </div> <div data-bbox="636 930 956 1026" style="border: 1px solid black; padding: 5px;"> <pre>Antenna Control CHANNEL EXIT ENTER</pre> </div>
<p>3. To switch between BAND SET 1, BAND SET 2 and CHANNEL, rotate</p> <div data-bbox="320 1254 524 1350" style="display: flex; align-items: center;">   </div>	<p>Select:</p> <ul style="list-style-type: none"> • BAND SET 1 or BAND SET 2 if you want to control equipment by frequency band • CHANNEL if you want to control equipment by channel frequency.

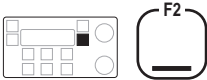
Action	Notes				
<p data-bbox="236 212 426 236">4. Press</p> 	<p data-bbox="684 212 893 236">The display shows:</p> <div data-bbox="689 256 1009 355" style="border: 1px solid black; padding: 5px;"><p data-bbox="697 261 897 280">LINK SETUP MENU</p><table data-bbox="697 284 919 331"><tr><td data-bbox="697 284 804 303">1-Pin</td><td data-bbox="833 284 919 303">2-Inhibit</td></tr><tr><td data-bbox="697 306 807 325">3-Antenna</td><td data-bbox="833 306 919 325">4-Reset</td></tr></table><p data-bbox="930 331 1005 351" style="text-align: right;">ENTER</p></div>	1-Pin	2-Inhibit	3-Antenna	4-Reset
1-Pin	2-Inhibit				
3-Antenna	4-Reset				
5. Exit Link Setup mode.	See <i>Link Setup mode enter/exit</i> on page 9-2.				



PIN setup

This procedure is used to set, change or cancel the transceiver PIN.

Setting a PIN is a security feature. No one will be able to use the transceiver unless they know the programmed PIN.

You must know the current PIN to be able to change or cancel use of a PIN.









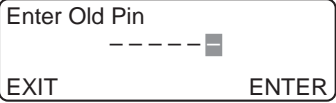
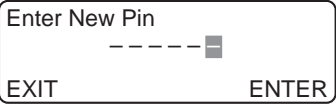

Do not forget your PIN!

If you do, you will be unable to use the transceiver. You will have to obtain a password from Codan to delete the PIN.

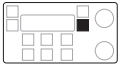
To set, change or cancel a PIN:

Action	Notes
1. Enter Link Setup mode.	See <i>Link Setup mode enter/exit</i> on page 9-2. The display shows: <div data-bbox="636 951 956 1046" style="border: 1px solid black; padding: 5px; margin-top: 10px;">LINK SETUP MENU 1-Pin 2-Inhibit 3-Antenna 4-Reset ENTER</div>

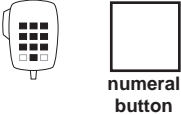
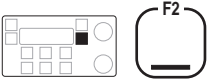
Action	Notes
<p>2. Enter 1</p>  	<p>If a PIN is currently set, the display shows:</p>  <p>If no PIN is currently set, the display shows:</p> 
<p>3. Is a PIN already set?</p> <p>Yes ➤ Step 4.</p> <p>No ➤ Step 6.</p>	
<p>4. Enter the current PIN</p>  	
<p>5. Press</p>  	<p>The transceiver beeps twice and switches off if you enter the wrong PIN. Switch the transceiver on and repeat the procedure.</p>

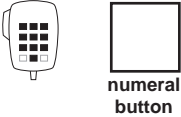
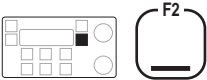
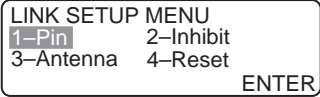
Action	Notes
<p>6. Enter the new PIN</p> 	<p>Enter up to 6 digits. To cancel the use of a PIN, enter 0.</p>
<p>7. Press</p> 	<p>The display shows:</p> 
<p>8. Enter the new PIN again</p> 	<p>The transceiver asks you to enter the PIN again to check that you are entering the right number. If the number is different the second time you enter it, the transceiver beeps. Enter the new PIN again from Step 6.</p>
<p>9. Press</p> 	<p>The display shows:</p> 
<p>10. Exit Link Setup mode.</p>	<p>See <i>Link Setup mode enter/exit</i> on page 9-2.</p>



Setup mode availability on/off

This procedure is used to switch on or off the availability of Setup mode.

After you have used Setup mode to set how the transceiver operates, denying casual access to Setup mode safeguards against accidental deletion or modification of programmed information.

For example, a transport manager controlling a fleet of vehicles might use this procedure to stop the transceivers installed in the vehicles from being modified once they have been set up.

To switch on or off the availability of Setup mode:

Action	Notes
<p>1. Enter Link Setup mode.</p>	<p>See <i>Link Setup mode enter/exit</i> on page 9-2.</p> <p>The display shows:</p> <div data-bbox="689 928 1009 1023" style="border: 1px solid black; padding: 5px;"> <pre>LINK SETUP MENU 1-Pin 2-Inhibit 3-Antenna 4-Reset ENTER</pre> </div>
<p>2. Enter 2</p> <div data-bbox="396 1155 456 1235" style="display: inline-block; vertical-align: middle;">  </div> <div data-bbox="505 1155 575 1270" style="display: inline-block; vertical-align: middle; margin-left: 20px;"> <div style="border: 1px solid black; width: 40px; height: 40px; margin-bottom: 5px;"></div> <p>numeral button</p> </div>	<p>The display shows:</p> <div data-bbox="689 1155 1009 1249" style="border: 1px solid black; padding: 5px;"> <pre>Setup Mode ENABLED Enable setup mode EXIT ENTER</pre> </div> <p>or</p> <div data-bbox="689 1321 1009 1415" style="border: 1px solid black; padding: 5px;"> <pre>Setup Mode DISABLED Disable setup mode EXIT ENTER</pre> </div>

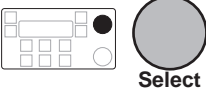
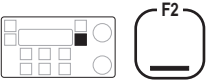
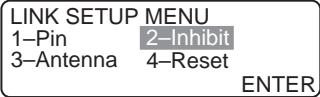
Action	Notes
<p>3. To switch between ENABLED and DISABLED, rotate</p> 	<p>Select:</p> <ul style="list-style-type: none">• ENABLED to allow use of Setup mode• DISABLED to prevent use of Setup mode.
<p>4. Press</p> 	<p>The display shows:</p> 
<p>5. Exit Link Setup mode.</p>	<p>See <i>Link Setup mode enter/exit</i> on page 9-2.</p>



Transceiver reset to factory settings

This procedure is used to reset the transceiver to factory settings.

You can:

- delete all unprotected channels
- reset user settings to the factory default values
- reset user settings to the factory default values and delete all channels (full transceiver reset to factory condition).









Think carefully before deleting all channels since this includes all your protected channels set up by Codan! If you delete all channels and your transceiver is not fitted with the option TXE, you will be unable to use the transceiver until your transmit channels are entered again by Codan.

User settings include all settings in the transceiver except for:

- channel information
- PIN
- transceiver options installed by Codan or enabled by password
- display brightness and contrast settings.

To reset some or all of the transceiver settings to their factory values:

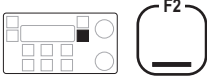
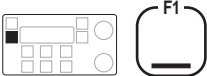
Action	Notes
<p>1. Enter Link Setup mode.</p>	<p>See <i>Link Setup mode enter/exit</i> on page 9-2.</p> <p>The display shows:</p> <div data-bbox="636 466 956 563" style="border: 1px solid black; padding: 5px;"> <pre>LINK SETUP MENU 1-Pin 2-Inhibit 3-Antenna 4-Reset ENTER</pre> </div>
<p>2. Enter 4</p> <div data-bbox="342 692 524 807" style="display: flex; align-items: center; gap: 20px;">   </div>	<p>The display shows:</p> <div data-bbox="636 687 956 783" style="border: 1px solid black; padding: 5px;"> <pre>Press F2 to: Delete all unprotected channels EXIT RESET</pre> </div>
<p>3. To switch between the three types of reset, rotate</p> <div data-bbox="318 1007 524 1102" style="display: flex; align-items: center; gap: 20px;">   </div>	<p>Select:</p> <ul style="list-style-type: none"> • Delete all unprotected channels—to delete just unprotected channels • Reset user settings to factory defaults—to reset user settings but not channels • Reset user settings, delete all channels—to reset user settings and all channels—full transceiver reset. <div data-bbox="676 1377 949 1441" style="text-align: right;">  <i>Use with caution!</i> </div>

- | Action | Notes |
|--|--|
| <p>4. Press</p>  | <p>The display looks like one of the following:</p> <div data-bbox="689 295 1009 391" style="border: 1px solid black; padding: 5px;"> <p>Press F2 to confirm:
Delete all unprotected channels
EXIT RESET</p> </div> <div data-bbox="689 411 1009 507" style="border: 1px solid black; padding: 5px;"> <p>Press F2 to confirm:
Reset user settings to factory defaults
EXIT RESET</p> </div> <div data-bbox="689 528 1009 624" style="border: 1px solid black; padding: 5px;"> <p>Press F2 to confirm:
Reset user settings, delete all channels
EXIT RESET</p> </div> <p>To exit this procedure without resetting anything, press</p>  |
| <p>5. To start the reset, press</p>  | <p>The display shows:</p> <div data-bbox="689 965 1009 1061" style="border: 1px solid black; padding: 5px;"> <p>LINK SETUP MENU
1-Pin 2-Inhibit
3-Antenna 4-Reset ENTER</p> </div> |
| <p>6. Exit Link Setup mode.</p> | <p>See <i>Link Setup mode enter/exit</i> on page 9-2.</p> |



Link Setup mode

10 Display messages

This chapter lists all messages that are shown on the transceiver display. These include:

- transceiver status messages
- operator error messages
- system error messages.

Some error messages are accompanied by one or more beeps.

Message	Meaning	Action
ALE ACK timeout	The transceiver cannot communicate with the 9300 ALE controller.	If the 9300 ALE controller is connected, check the cables between the ALE and transceiver. If no ALE is connected, see <i>Chapter 7, RS-232 connected equipment</i> to remove ALE from the setup. If you need help, contact your Codan agent.
ALE not initialised	The 9300 ALE controller has not been initialised.	To initialise the ALE controller, switch it off and then on again. If no ALE controller is connected, see <i>Chapter 7, RS-232 connected equipment</i> to remove ALE from the setup.
Antenna untuned	The auto tuner or antenna is not tuned.	Press the Tune button to tune the antenna.
Auto-tuning	The antenna is automatically being tuned prior to transmitting.	None.
Bad ALE ACK	The transceiver cannot communicate with the 9300 ALE controller.	If the 9300 ALE controller is connected, check the cables between the ALE and transceiver. If no ALE is connected, see <i>Chapter 7, RS-232 connected equipment</i> to remove ALE from the setup. If you need help, contact your Codan agent.
Bad ALE SCall channel	A channel in the ALE scan table has not been assigned to a selcall group.	Assign a selcall group (S1–S5) to this ALE selcall channel. See <i>Chapter 8, Selcall address setup</i> .

Message	Meaning	Action
Bad record type XX	Data was corrupted during XP programming.	Check the XP cables. Switch the transceiver off and then on again. If the problem remains, contact your Codan agent for help.
Bad type/inst XX/XX	The transceiver detected an internal data fault.	Switch the transceiver off and then on again. If the problem remains, contact your Codan agent for help.
BBRAM Ck/Sum Err	Data in the battery backup RAM has become corrupted.	Contact your Codan agent for help.
BBRAM update failed	The transceiver cannot read/write data to the battery backup RAM.	Contact your Codan agent for help.
Call stack empty	There are no calls stored in the call memory.	Refer to the <i>HF SSB transceiver user guide, Chapter 5, Reviewing calls held in memory.</i>
Channel not found	This channel number is not used.	Select a channel that exists.
Channel protected	The current channel is protected against change or deletion.	Contact your Codan agent if you need to delete or change this channel.
Channel space full	The maximum number of channels have been set up.	If you want to add channels, first delete unwanted channels that are not protected (NP). See <i>Chapter 3, Channel deletion.</i> For protected channels (P), contact your Codan agent for help.
Channel used	This channel already exists and you are about to change its channel settings.	Continue unless you do not want to change this channel. See <i>Chapter 3, Channel creation and editing.</i>

Message	Meaning	Action
Clarifier	Clarifier mode has been selected.	Clarify by using the Select knob on the control panel. Refer to the <i>HF SSB transceiver user guide, Chapter 3, Using Clarifier mode.</i>
Cloning failed	Cloning the transceiver has failed.	Check the programming cables. Switch the transceiver off and then on again. Try cloning again. If the problem remains, contact your Codan agent for help.
Cloning finished	Cloning has completed successfully.	None.
Completed	The transceiver has finished loading information from the 9300 ALE controller.	None.
Data	The transceiver is in Data mode.	None.
Disconnect Err	The transceiver received a message to disconnect the call when no IPC-500 was in operation.	If the problem persists, contact your Codan agent for help.
Emergency abort	The emergency call was cancelled.	None.
Empty scan table	No channels have been set up in the selected scan table.	To set up a scan table, see <i>Chapter 3, Scan table creation.</i>
Error PIN mismatch	You entered a different number the second time you entered your new PIN.	Set up the PIN again. See <i>Chapter 9, PIN setup.</i>
Error: no self ID	Your address has not been set up.	See <i>Chapter 8, Selcall address setup.</i>

Message	Meaning	Action
External RAM bad	The transceiver cannot read/write to parallel RAM on power up.	Switch the transceiver off and then on again. If the problem remains, contact your Codan agent for help.
Frequency not found	No channel has been set up for this frequency.	If you want to receive on this frequency, see <i>Chapter 3, Channel creation and editing</i> . If you want to send on this frequency, contact your Codan agent.
FSK calibration fail	The selcall decoder is not calibrated.	Switch the transceiver off and then on again. If the message reappears, contact your Codan agent for help.
I2C bus error XXXX:XXXX	There is a major hardware fault on one of the I ² C bus lines.	Contact your Codan agent for help.
Intrnl Tmr Alloc Err	The transceiver detected an internal timer allocation error.	Switch the transceiver off and then on again. If the problem remains, contact your Codan agent for help.
Invalid IPC channel	This channel is not available for IPC-500 use.	Contact your Codan agent for help.
Is emergency channel	This is a digital emergency channel.	You can only delete this channel after removing it from the emergency call table.
Link established	The transceiver has set up an ALE link with the other station.	Proceed with your call. For details on ALE, see <i>Chapter 5, ALE option settings</i> .
Link failed	The transceiver failed to set up an ALE link. The call has failed.	Try sending another ALE call. For details on ALE, see <i>Chapter 5, ALE option settings</i> . Contact your Codan agent if you need help.

Message	Meaning	Action
Loading ALE data	The transceiver is loading information from the 9300 ALE controller.	Wait for loading to finish.
Low battery	The battery voltage has dropped below 10 volts.	Recharge or change the battery.
No ALE scan table	No channels have been set up in the ALE scan table.	To set up an ALE scan table, see <i>Chapter 3, Scan table creation</i> (set scan type ALE).
No call available	Either selective calling has not been enabled or no selcall group is assigned to this channel.	For changing channel settings, see <i>Chapter 3, Channel creation and editing</i> . Select one of the selcall groups S1–S5. If the channel is protected, contact your Codan agent for help.
No channels fitted	No channels have been set up in the transceiver.	Contact your Codan agent for help.
No deflt rec for XX	The transceiver could not read a default record.	Switch the transceiver off and then on again. If the problem remains, contact your Codan agent for help.
No destination ID	No address to call has been set up.	Refer to the <i>HF SSB transceiver user guide, Chapter 4, Selcall</i> for how to enter the address of the station you want to call.
No external unit connected	The remote station is not configured to respond.	None.

Message	Meaning	Action
No GPS information	No data was received from the GPS receiver.	If no GPS receiver is connected, switch off GPS error beeping (see <i>Chapter 6, GPS timeout on/off</i>). If a GPS receiver is plugged into the RS232 socket, make sure that the RS-232 setting is set to GPS NMEA-0183 (see <i>Chapter 7, RS-232 connected equipment</i>). Check cables.
No real time clock	The clock is faulty.	Contact your Codan agent for help.
No response	There was no response from the destination station after sending a GPS, page or status call.	Find the best signal path to use by sending selective beacon calls on available channels. Send the page call again. If there is still no response, check that the privacy number is set correctly (see <i>Chapter 5, Call privacy on/off</i>).
No Selcall send	This channel does not allow you to send selective calls.	Contact your Codan agent for help.
No tones programmed	No tone call frequencies have been set up.	See <i>Chapter 8, Tone call setup</i> .
Not enabled	This option is switched off.	To switch the option on, refer to the relevant procedure in this book.
Not tuned	The antenna has not been tuned.	Press the Tune button to tune the antenna.
Option not fitted	This option has not been enabled in the transceiver.	If you want this option, contact your Codan agent.
Page call succeeded	A page call was acknowledged.	None.

Message	Meaning	Action
Parallel EEPROM bad	Data in the parallel E ² PROM has become corrupted.	Contact your Codan agent for help.
Program inhibited	The current channel is protected from deletion.	If you want to copy this channel to another channel number, see <i>Chapter 3, Channel creation and editing</i> . If you need help, contact your Codan agent.
PTT cutout	Transmission time has exceeded the set limit.	If you want to change the time limit, see <i>Chapter 7, PTT transmit cutout</i> .
PTT inhibited	The current channel is a receive-only channel.	Select another channel if you want to transmit.
Queue full	The internal task queue is full.	Switch the transceiver off and then on again. If the problem remains, contact your Codan agent for help.
RAM fault	The transceiver cannot read data from the parallel RAM.	Contact your Codan agent for help.
RFDS emgcy channel	You cannot set up an RFDS channel as an emergency selcall channel.	Select a non-RFDS channel (Australia only).
RTC Ck/Sum Err	The transceiver detected a real time clock checksum error.	Switch the transceiver off and then on again. Check the clock's lithium backup battery. If the problem remains, contact your Codan agent for help.
S ³ call mute disabled	Selcall mute availability is switched off.	To make selcall mute available, see <i>Chapter 8, Selcall mute availability on/off</i> .

Message	Meaning	Action
Scan abort	Scanning has stopped because the PTT or another button was pressed.	To exit Scan mode, refer to the <i>HF SSB transceiver user guide, Chapter 3, Scanning for incoming calls.</i>
Scan inhibited	Scan table editing is not currently allowed.	To allow scan tables to be edited, see <i>Chapter 8, Scan table editing on/off.</i>
Scan program full	This scan table is full because it contains the maximum number of 10 channels.	See <i>Chapter 3, Scan table creation.</i>
Scan-tuning	The antenna is automatically being tuned now that Scan mode has been initialised.	None.
SEEPROM Ck/Sum Err	Data in the serial E ² PROM has become corrupted.	Contact your Codan agent for help.
Serial BBPROM bad	The transceiver cannot read/write reliably to the battery backup ROM on power up.	Contact your Codan agent for help.
Serial EEPROM bad	The transceiver cannot read/write reliably to the serial E ² PROM on power up.	Contact your Codan agent for help.
Serial EEPROM fail XX	The transceiver detected an error in reading/writing data to the serial E ² PROM.	Contact your Codan agent for help.
Telcall disabled	Sending telcalls from the transceiver is not currently allowed.	To switch the availability of telcalls on, see <i>Chapter 8, Telcall availability on/off.</i>

Message	Meaning	Action
Tone is disabled	You cannot send a tone call because no tone call group has been assigned to this channel.	To assign a tone call group to this channel, see <i>Chapter 3, Channel creation and editing</i> .
Transmit inhibited	The current channel is a receive-only channel.	Select a channel enabled for transmission.
Tune abort	Antenna tuning has been cancelled because the PTT button on the microphone has been pressed.	If necessary, tune the antenna again.
Tune fail	Antenna tuning failed.	Check the position of the antenna (for example, too close to buildings), then press the Tune button to tune the antenna again.
Tune pass	The antenna was successfully tuned.	None.
Tuner fault	The transceiver failed to tune the antenna within two minutes.	Check the installation (for example, cables to the antenna tuner), then press the Tune button to tune the antenna again. If the problem remains, contact your Codan agent for help.
Tuning	The Tune button was pressed and the antenna is now being tuned.	None.
Unknown error: XX	The transceiver detected an unknown data error.	Contact your Codan agent for help.
Unlock error VC01	VC01 is unlocked.	Contact your Codan agent for help.
Unlock error VC01&2	VC01 and VC02 are unlocked.	Contact your Codan agent for help.

Message	Meaning	Action
Unlock error VC02	VC02 is unlocked.	Contact your Codan agent for help.
Value too high	The entered number is too large.	Enter the correct number.
Value too low	The entered number is too small.	Enter the correct number.
Writing SEE defaults	Now reprogramming serial E ² PROM with default settings.	None.
Out of PA range	A channel has a frequency outside the PA operating frequency band.	Contact your Codan agent for help.



Display messages

11 Appendix

This chapter:

- describes the pin arrangements of connectors on the transceiver and control head (11-2)
- lists the ancillary equipment you can connect to the transceiver (11-8)
- explains how to use the optional RS-232/I²C Interface to connect combinations of ancillary equipment (11-10)
- lists the transceiver specifications (11-14)
- lists the accessories available for the transceiver (11-15).

Connectors

Only suitably qualified personnel should use the information contained in this section. Failure to observe the stated and implied criteria could result in damage to the transceiver.

This section covers:

- the microphone socket
- the **Antenna Control** connector
- the **Remote Control** connector
- the **GP** connector
- the **RS232** socket
- the loudspeaker **L/S** socket
- the **Ext Alarm** socket.

Microphone socket

The microphone socket is unmarked. It is located at the left of the front panel.

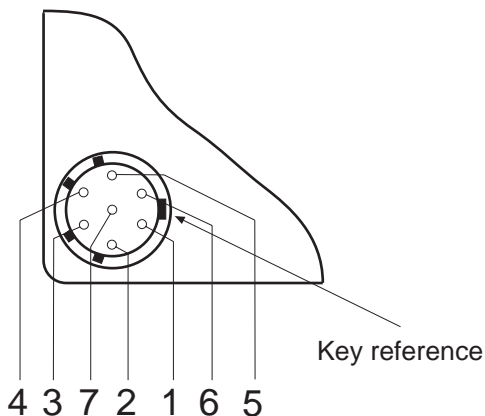

Pin	Function
1	Loudspeaker audio output
2	Microphone input
3	Ground
4	Data in
5	PTT in (active low) and data out
6	Battery (switched)
7	Front panel speaker (ground return)

Antenna Control connector

The **Antenna Control** connector is located at the left of the back panel.

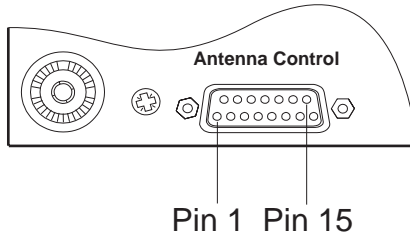

Pin	Function
1	Binary coded decimal channel 4
2	Binary coded decimal channel 8
3	Not used
4	Tune in and out (active low)
5	Scan antenna (active low)
6	Not used
7	Not used
8	PTT out (+10V=Tx)
9	Binary coded decimal channel 1
10	Binary coded decimal channel 2
11	Tuned in
12	Battery (switched)
13	Battery (switched)
14	Ground
15	Ground

Remote Control connector

The **Remote Control** connector is located at the right of the back panel.



*Make sure that the transceiver is disconnected from the DC power source before connecting anything to the **Remote Control** connector.*

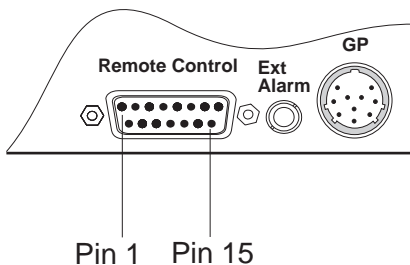

Pin	Function
1	Speaker
2	Remote PTT
3	External audio input
4	Power on
5	Data (I ² C bus, 5V)
6	Not used
7	Clock (I ² C bus, 5V)
8	Rx and Tx indicator
9	Ground
10	Ground
11	Transmitter audio input
12	Receiver demodulated output
13	Receiver audio output
14	Interrupt (I ² C bus, 5V)
15	Battery (switched)

GP connector

The 10-pin **GP** connector is located at the right of the back panel. It is used for ALE controllers, modems and fax interfaces.

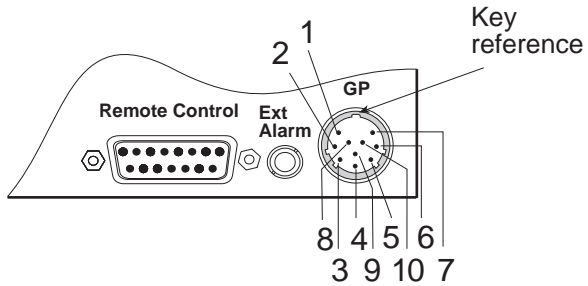

Pin	Function
1	Ground
2	Receiver output
3	Transmitter input
4	Quiet line
5	Alarm input
6	PTT input (active low)
7	Scan
8	Battery (switched)
9	RS-232 receive
10	RS-232 transmit

RS-232 socket

The RS-232 socket is labelled **RS232**. It is located at the middle of the back panel.

Connection	Function
Tip	Data input to transceiver
Ring	Data output from transceiver
Sleeve	Ground

Loudspeaker socket

The Loudspeaker socket is labelled **L/S**. It is located at the middle of the back panel.

Connection	Function
Tip	Speaker audio output
Sleeve	Ground

External alarm socket

The external alarm socket is labelled **Ext Alarm**. It is located at the right of the back panel.

Connection	Function
Tip	Relay switch contact
Sleeve	Relay switch contact (ground)



Connecting ancillary equipment

The following ancillary equipment plugs into the rear panel of the transceiver:

- 8571 Remote control interface
- 9300 ALE controller
- 9366 or 9330 control head
- automatic antenna and antenna tuner
- computer
- data and fax modem
- external alarm
- GPS receiver
- IPC-500 telephone interconnect.

The following table shows the connections on the transceiver rear panel for ancillary equipment.

Equipment connected to either the **RS-232** socket or **GP** connector on the transceiver rear panel is controlled by the transceiver's RS-232 and baud rate settings. See *Chapter 7, RS-232 connected equipment* and *RS-232 connection baud rate*.

If you want to connect a combination of ALE controllers, computers and GPS receivers, you will need to use the optional RS-232/I²C Interface described on page 11-10.

Ancillary equipment	Transceiver rear panel connection	Notes
8571 Remote control interface	Remote Control connector	
9300 ALE controller	GP connector	Set RS-232 setting to 9300 ALE and baud rate to 9600.
9366 or 9330 control head	Remote Control connector	
Automatic antenna and antenna tuners	Antenna Control connector	
Computer	RS-232 socket	Set RS-232 setting to COMPUTER and baud rate to the value used by the computer (typically 9600).
Data and fax modems	GP connector	
Extension loudspeaker	L/S socket	
External alarm	Ext Alarm socket	
GPS receiver	RS-232 socket	Set RS-232 setting to GPS NMEA-0183 and baud rate to the value used by the GPS receiver (typically 4800).
IPC-500 telephone interconnect	Remote Control connector	



Using the optional RS-232/I²C Interface

The RS-232/I²C Interface is an adaptor that plugs into the **Remote Control** connector. It provides two additional sockets for connecting a GPS receiver and computer.

You need to use this interface when connecting any combination of ALE controllers, modems, GPS receivers and computers as the transceiver can only support one RS-232 port.

The interface has:

- a **GPS** socket for a GPS receiver
- a **COMPUTER** socket for a computer
- a **Remote Control** connector for remote control equipment or a control head.

Internal switches control the equipment connections:

- the **GPS** switch controls use of the **GPS** socket
- the **COMP** switch controls use of the **COMPUTER** socket
- the **I²C** switch is only used if a second interface is connected
- the **GPS A** and **GPS B** switches set the baud rate for **GPS** socket
- the **COMP A** and **COMP B** switches set the baud rate for the **COMPUTER** socket.

Setting up the RS-232/I²C Interface

If you need assistance in setting up the interface, contact your Codan agent.

The internal switches are labelled on the inside of the cover to the interface as follows:

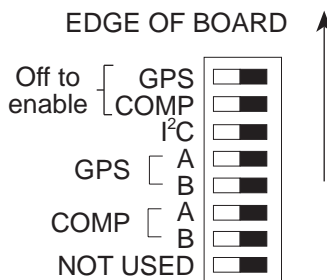

Switches may only mark the **On** or **Off** position.

The table below shows the possible baud rate settings for either pair of **GPS A/B** and **COMP A/B** switches:

GPS A or COMP A switch	GPS B or COMP B switch	Setting
on	on	9600 baud (no parity, 1 stop bit)
off	on	4800 baud (no parity, 1 stop bit)
on	off	2400 baud (no parity, 1 stop bit)
off	off	1200 baud (no parity, 1 stop bit)

To set up the interface:

Action	Notes
<p>1. Remove the single screw securing the back cover of the interface and remove the cover.</p>	
<p>2. Do you want to use the GPS socket? Yes ➤ Step 3. No ➤ Step 5.</p>	<p>If you are not using this socket, make sure that the GPS switch is set to the on position (only the On or Off position may be marked).</p>
<p>3. Set the GPS switch to the off position.</p>	<p>The off position enables the socket.</p>
<p>4. Use the GPS A and GPS B switches to set the baud rate for the GPS receiver.</p>	<p>Refer to the table above. The most common setting is 4800 baud.</p>
<p>5. Do you want to use the COMPUTER socket ? Yes ➤ Step 6. No ➤ Step 8.</p>	<p>If you are not using this socket, make sure that the COMP switch is set to the on position (only the On or Off position may be marked).</p>
<p>6. Set the COMP switch to the off position.</p>	<p>The off position enables the socket.</p>

Action	Notes
7. Use the COMP A and COMP B switches to set the baud rate for the computer.	Refer to the table above. The most common setting is 9600 baud.
8. Replace the cover and secure it with the screw.	

If you want to connect more ancillary equipment such as an additional computer, plug a second interface into the **Remote Control** connector of the first interface.

Make sure that the **I²C** switches are not set to the same position for both units. Set one to the on position and the other to the off position.



Specifications

Channel capacity	Refer to the front of the <i>HF SSB transceiver user guide</i> .
Frequency range	Refer to the front of the <i>HF SSB transceiver user guide</i> .
Operating mode	Refer to the front of the <i>HF SSB transceiver user guide</i> .
Transmitted power	Refer to the front of the <i>HF SSB transceiver user guide</i> .
Supply voltage	12V DC nominal, negative earth Normal operating range 10.5V to 15V DC Maximum operating range 9V to 16V DC Reverse polarity protection provided
Overvoltage protection	Shutdown at 16V DC (nominal) for duration of overvoltage
Supply current	Receive (no signal): 0.75A Transmit J3E voice: 6A (average) J3E two tone: 9–12A
Size and weight	HF SSB transceiver (excluding vehicle mounting frame) Dimensions: 250mm W x 320mm D x 78mm H Weight: 3.3kg 9366 or 9330 control head (including mounting bracket) Dimensions: 140mm W x 40mm D x 80mm H Weight: 0.4kg



Accessories

The following accessories are available for your transceiver:

Code	Accessories
112	Vehicle installation hardware kit.
117	Vehicle mounting cradle—front entry. Supplied complete with 6-metre transceiver DC power cable. This cradle is normally supplied with the extended control version of the transceiver.
118	Vehicle mounting cradle—top or bottom entry. Supplied complete with 6-metre transceiver DC power cable.
121	2-module clamp suitable for locking the transceiver with another item of equipment having the same physical design.
122	3-module clamp suitable for locking the transceiver with two other items of equipment having the same physical design.
649	Extension loudspeaker.
704	Vehicle interference suppression kit.
711	Bulkhead mounting fuse holder for transceiver DC power cable—supplied with 32 amp fuse.
712	32 amp fuse for code 711.
752	RS-232 interface unit. To provide two additional RS-232 facilities for GPS and computer connection.
2051	Service manual for this series of transceivers.
9366 or similar	Control head complete with hand PTT/key-pad control microphone and 6 metres of interface cable fitted with connectors for 9360 or similar.



Index

—9—		—C—	
99-beacon call response on/off	8-27	calibration of clock	5-21
—A—		call	
accessories	11-15	lockout	8-16
address		preamble length	5-17
alphanumeric setup	5-2	privacy on/off	5-19
display on power up	7-16	canned message setup	7-2
numeric setup	8-6	channel	
size compatibility	8-13	copying	3-4, 3-11
ALE		creating and editing	3-2
alphanumeric address setup	5-2	creating in Free-Tune Receiver	3-17
connecting the unit	11-8	deleting	3-21
connection settings	11-10	options	3-3
reset	5-4	protecting from deletion	3-2
scanning	3-22, 8-2	recall by frequency	7-22
settings	5-6	receive-only type	3-3
sounding interval	5-13	settings	3-3
alphanumeric address setup	5-2	transmit type	3-3, 3-4, 3-11
ancillary equipment	2-13	clock	
connecting the units	11-8	calibration	5-21
connection settings	11-10	setting	5-23
antenna		clone a transceiver	5-28
band or channel control	9-5	computer	
connector	11-4	connecting the unit	11-8
setup	2-13	connection settings	11-10
automatic link establishment	<i>See</i> ALE	connecting ancillary equipment	11-8
—B—		connection settings	11-8, 11-10
battery power supply	2-11	connectors	11-2
beep loudness	5-15	antenna control	11-4
brightness of display	6-2	external alarm	11-7
		GP	7-20, 7-26, 7-29, 11-6
		loudspeaker	11-7
		microphone	11-3
		remote control	11-5
		RS-232	7-26, 7-29, 11-7
		contrast of display	6-4

Index

- control head
 - grounding 2-12
 - mounting 2-8
- copying a channel 3-4, 3-11
- creating
 - channels 3-2, 3-17
 - scan table 3-22
 - telephone directory 3-29
- D—**
- deleting
 - channel 3-21
 - PIN 7-8
 - scan table 3-27
- diagnostics display 6-6
- display
 - brightness 6-2
 - contrast 6-4
 - diagnostics 6-6
 - frequency 6-8
 - GPS information 6-21
 - messages 10-1
- E—**
- earthing 2-12
- editing
 - channel 3-2
 - scan table 3-22, 8-4
 - telephone directory 3-29
- emergency selcall
 - receive setup 6-11
 - transmit setup 6-15
- enabling transceiver option 7-5
- error messages 10-1
- external alarm connector 11-7
- F—**
- fault finding error messages 10-1
- fixed base station 2-2
- Free-Tune Receiver mode
 - availability on/off 6-19
 - creating receive-only channels 3-17
- frequency display 6-8
- fuses 11-15
- G—**
- gain on/off 7-24
- global positioning system *See* GPS
- GP connector 7-20, 7-26, 7-29, 11-6
- GPS
 - connecting the unit 11-8
 - connection settings 11-10
 - display on/off 6-21
 - timeout on/off 6-23
- grounding 2-12
- I—**
- ID of transceiver 7-5
- installing
 - control head and loudspeaker 2-8
 - transceiver 2-5
- L—**
- LCD *See* display
- Link Setup mode
 - antenna band or channel control 9-5
 - enter/exit 9-2
 - PIN setup 9-8
 - Setup mode availability on/off 9-11
 - transceiver reset 9-13
- lockout 8-16
- loudness of beeping 5-15
- loudspeaker
 - connector 11-7
 - mounting 2-8
- M—**
- messages
 - canned page call 7-2
 - full list 10-1
 - on power up 7-10
- microphone connector 11-3
- mobile station 2-3

mounting
 control head and loudspeaker 2-8
 transceiver 2-5
mute
 during scanning 3-22
 on power up 7-13
 selcall 8-18

—O—

operating the transceiver *See user guide*
options
 enabling 7-5
 TXE 3-4, 3-11

—P—

page call message setup 7-2
password
 deleting PIN 7-8
 enabling transceiver option 7-5
personal identification number *See* PIN
PIN
 deleting 7-8
 setup 9-8
power supply 2-11
power up
 address display on/off 7-16
 message on/off 7-10
 mute setting 7-13
preamble length 5-17
privacy on/off 5-19
PTT
 release beep on/off 7-18
 transmit cutout 7-20

—R—

Radphone Direct Dial (RDD) 8-7
rear panel connectors 11-2
recall channels by frequency on/off 7-22
receive frequency 3-2
release beep for PTT 7-18
remote control connector 11-5
reset

ALE 5-4
transceiver 9-13
RF gain on/off 7-24
RS-232
 connected equipment 7-26
 connection baud rate 7-29
 I²C Interface 11-10
 socket 7-26, 7-29, 11-7

—S—

scan table
 automatic scanning start 8-2
 creating 3-22
 deleting 3-27
 editing on/off 8-4
 types of 3-22
selcall
 address setup 8-6
 address size compatibility 8-13
 emergency receive setup 6-11
 emergency transmit setup 6-15
 group 8-6
 lockout on/off 8-16
 mute availability on/off 8-18
 selective calling 1-5
Setup mode
 advanced users 4-7
 availability on/off 9-11
 list of procedures 4-3
 tree 4-8
 using 4-1
sockets *See* connectors
sounding interval 5-13
specifications 11-14
station
 fixed base 2-2
 mobile 2-3
status call availability on/off 8-20

—T—

telcall availability on/off 8-22
telephone directory creation 3-29
tone call setup 8-24

Index

- | | | | |
|-------------|-----------------------|--------------------------|-----------------------|
| transceiver | | | |
| accessories | 11-15 | transmit cutout | 7-20 |
| cloning | 5-28 | transmit frequency | 3-2 |
| grounding | 2-12 | troubleshooting messages | 10-1 |
| ID | 7-5 | TXE option | 3-4, 3-11 |
| mounting | 2-5 | | |
| options | 7-5 | | —U— |
| reset | 9-13 | using the transceiver | <i>See user guide</i> |
| using | <i>See user guide</i> | | |